



**User Manual**

## **AIMB-286**

**Intel® Core™ i7/i5/i3/Pentium/  
Celeron LGA1151 Mini-ITX with  
DP++/HDMI/LVDS (or eDP), 6  
COM & 8 USB, 3 LAN, and  
PCIex4**

**ADVANTECH**

*Enabling an Intelligent Planet*

---

## Copyright

The documentation and the software included with this product are copyrighted 2019 by Advantech Co., Ltd. All rights are reserved. Advantech Co., Ltd. reserves the right to make improvements in the products described in this manual at any time without notice.

No part of this manual may be reproduced, copied, translated or transmitted in any form or by any means without the prior written permission of Advantech Co., Ltd. Information provided in this manual is intended to be accurate and reliable. However, Advantech Co., Ltd. assumes no responsibility for its use, nor for any infringements of the rights of third parties, which may result from its use.

## Acknowledgements

IBM and PC are trademarks of International Business Machines Corporation.

Intel® Core™ i7/i5/i3, Pentium, Celeron® is trademark of Intel Corporation

All other product names or trademarks are properties of their respective owners.

## Product Warranty (2 years)

Advantech warrants to you, the original purchaser, that each of its products will be free from defects in materials and workmanship for two years from the date of purchase.

This warranty does not apply to any products which have been repaired or altered by persons other than repair personnel authorized by Advantech, or which have been subject to misuse, abuse, accident or improper installation. Advantech assumes no liability under the terms of this warranty as a consequence of such events.

Because of Advantech's high quality-control standards and rigorous testing, most of our customers never need to use our repair service. If an Advantech product is defective, it will be repaired or replaced at no charge during the warranty period. For out-of-warranty repairs, you will be billed according to the cost of replacement materials, service time and freight. Please consult your dealer for more details.

If you think you have a defective product, follow these steps:

1. Collect all the information about the problem encountered. (For example, CPU speed, Advantech products used, other hardware and software used, etc.) Note anything abnormal and list any onscreen messages you get when the problem occurs.
2. Call your dealer and describe the problem. Please have your manual, product, and any helpful information readily available.
3. If your product is diagnosed as defective, obtain an RMA (return merchandise authorization) number from your dealer. This allows us to process your return more quickly.
4. Carefully pack the defective product, a fully-completed Repair and Replacement Order Card and a photocopy proof of purchase date (such as your sales receipt) in a shippable container. A product returned without proof of the purchase date is not eligible for warranty service.
5. Write the RMA number visibly on the outside of the package and ship it prepaid to your dealer.

Part No. 2006028600

Printed in China

Edition 1

February 2019

# A Message to the Customer

## Advantech Customer Services

Each and every Advantech product is built to the most exacting specifications to ensure reliable performance in the harsh and demanding conditions typical of industrial environments. Whether your new Advantech equipment is destined for the laboratory or the factory floor, you can be assured that your product will provide the reliability and ease of operation for which the name Advantech has come to be known. Your satisfaction is our primary concern. Here is a guide to Advantech's customer services. To ensure you get the full benefit of our services, please follow the instructions below carefully.

## Technical Support

We want you to get the maximum performance from your products. So if you run into technical difficulties, we are here to help. For the most frequently asked questions, you can easily find answers in your product documentation. These answers are normally a lot more detailed than the ones we can give over the phone.

So please consult this manual first. If you still cannot find the answer, gather all the information or questions that apply to your problem, and with the product close at hand, call your dealer. Our dealers are well trained and ready to give you the support you need to get the most from your Advantech products. In fact, most problems reported are minor and are able to be easily solved over the phone.

In addition, free technical support is available from Advantech engineers every business day. We are always ready to give advice on application requirements or specific information on the installation and operation of any of our products.

---

# Declaration of Conformity

## FCC Class B

This device complies with the requirements in part 15 of the FCC rules:

Operation is subject to the following two conditions:

- This device may not cause harmful interference
- This device must accept any interference received, including interference that may cause undesired operation.

This equipment has been tested and found to comply with the limits for a Class B digital device, pursuant to Part 15 of the FCC Rules. These limits are designed to provide reasonable protection against harmful interference when the equipment is operated in a commercial environment. This equipment generates, uses, and can radiate radio frequency energy and, if not installed and used in accordance with the instruction manual, may cause harmful interference to radio communications. Operation of this device in a residential area is likely to cause harmful interference in which case the user will be required to correct the interference at his/her own expense. The user is advised that any equipment changes or modifications not expressly approved by the party responsible for compliance would void the compliance to FCC regulations and therefore, the user's authority to operate the equipment.

**Caution!** *There is a danger of a new battery exploding if it is incorrectly installed. Do not attempt to recharge, force open, or heat the battery. Replace the battery only with the same or equivalent type recommended by the manufacturer. Discard used batteries according to the manufacturer's instructions.*



## CPU Compatibility

Processor Number	Max_TDP	Code Name	Cores/Threads	S-Spec	Lithography
i7-8700	65W	Coffee Lake	6C/12T	SR3QS	14nm
i5-8500	65W	Coffee Lake	6C/6T	SR3XE	14nm
i3-8100	65W	Coffee Lake	4C/4T	SR3N5	14nm
G5400	54W	Coffee Lake	2C/4T	SR3X9	14nm
G4900	54W	Coffee Lake	2C/2T	SR3W4	14nm
i7-8700T	35W	Coffee Lake	6C/12T	SR3WX	14nm
i5-8500T	35W	Coffee Lake	6C/6T	SR3XD	14nm
i3-8100T	35W	Coffee Lake	4C/4T	SR3X8	14nm
G5400T	35W	Coffee Lake	2C/4T	SR3XB	14nm
G4900T	35W	Coffee Lake	2C/2T	SR3YP	14nm

## Memory Compatibility

Category	Speed	Capacity	Vendor	Chip_PN	ADVANTECH P/N	ECC
DDR4	2666	8GB	Advantech	SEC 737 K4A4G08 5WE BCTD	SQR- SD4N8G2K6SNEEB	N
DDR4	2400	16G	Advantech	SEC 749 K4A8G08 5WB BCRC	SQR- SD4M16G2K4SNBB	N
DDR4	2400	4G	Advantech	SEC 749 K4A4G08 5WE BCRC	SQR- SD4M4G2K4SNEEB	N
DDR4	2666	4G	Advantech	SEC 807 K4A4G08 5WE BCTD	SQR- SD4N4G2K6SNEEB	N
DDR4	2133	16G	Advantech	SEC 546 K4A8G08 5WB BCPB	AQD-SD4U16N21- SE	N
DDR4	2133	8G	Advantech	SEC 552 BCPB K4A4G085WD	AQD-SD4U8GN21- SG	N
DDR4	2400	8G	Advantech	H5AN8G8NAFR UHC 643V	SQR-SD4N- 8G2K4HBC	N
DDR4	2400	16G	Advantech	H5AN8G8NAFR UHC 643V	SQR-SD4N- 16G2K4HBC	N
DDR4	2400	16G	Advantech	H5AN8G8NAFR UHC	AQD-SD4U16N24- HE	N

## Ordering Information

P/N	Chip-set	DP1.2	LVDS/ eDP	HDMI 1.4	GbE LAN	COM	SATAIII	USB3. 0/2.0	M.2 B key	M.2 E key	PCIex4	TPM	AMP
AIMB-286F- 00A1E	H310	1	1/ (1)	1	3	6	3	4/4	1	1	1	(1)	(1)
AIMB-286G2- 00A1E	H310	1	1/ (1)	1	2	2	3	4/4	1	1	1	(1)	(1)
AIMB-286L- 00A1E	H310	1	0	1	1	2	2	4/0	1	1	0	0	0

\* ( ) is not populated when MP

---

## Initial Inspection

Before you begin installing your motherboard, please make sure that the following materials have been shipped:

- 1 x AIMB-286 Intel Core™ i7/i5/i3 LGA1151 Mini-ITX motherboard
- 1 x SATA HDD cable
- 1-to-2 serial port cable, 22 cm
- 1-to-4 serial port cable, 35 cm (only for F sku)
- 1 x SATA Power cable
- 1 x I/O port bracket
- 1 x Startup manual
- 1 x Warranty card

If any of these items are missing or damaged, contact your distributor or sales representative immediately. We have carefully inspected the AIMB-286 mechanically and electrically before shipment. It should be free of marks and scratches and in perfect working order upon receipt. As you unpack the AIMB-286, check it for signs of shipping damage. (For example, damaged box, scratches, dents, etc.) If it is damaged or it fails to meet the specifications, notify our service department or your local sales representative immediately. Also notify the carrier. Retain the shipping carton and packing material for inspection by the carrier. After inspection, we will make arrangements to repair or replace the unit.

# Contents

<b>Chapter 1</b>	<b>General Information .....</b>	<b>1</b>
1.1	Introduction .....	2
1.2	Features .....	2
1.3	Specifications .....	2
1.3.1	System .....	2
1.3.2	Memory .....	2
1.3.3	Input/Output .....	2
1.3.4	Graphics.....	3
1.3.5	Ethernet LAN .....	3
1.3.6	Industrial features .....	3
1.3.7	Mechanical and environmental specifications.....	3
1.4	Jumpers and Connectors .....	3
	Table 1.1: Connector and Header List.....	4
	Table 1.2: Jumper List.....	5
1.5	Board layout: Jumper and Connector Locations .....	5
	Figure 1.1 Jumper and Connector Location (Top Side).....	5
	Figure 1.2 Jumper and Connector Location (Bottom Side) .....	6
1.6	AIMB-286 Board Diagram .....	7
	Figure 1.3 AIMB-286 Board Diagram .....	7
1.7	Safety Precautions .....	7
1.8	Jumper Settings .....	8
1.8.1	How to Set Jumpers.....	8
1.8.2	CMOS Clear (JCMOS1).....	8
	Table 1.3: CMOS1 .....	8
1.8.3	Power Switch/HDD LED/SMBUS/Speaker Pin Header (JFP1) ....	9
	Table 1.4: Power Switch/HDD LED/SMBUS/Speaker Pin Header (JFP1).....	9
1.8.4	Power LED and Keyboard Lock Pin Header (JFP2) .....	9
	Table 1.5: Power LED and Keyboard Lock Pin Header (JFP2)...	9
1.8.5	Watchdog Timer Output and OBS Beep (JWDT1+JOBS1) .....	9
	Table 1.6: Watchdog Timer Output and OBS Beep (JWDT1+JOBS1).....	9
1.8.6	ATX/AT Mode Selection (PSON1) .....	10
	Table 1.7: ATX/AT Mode Selection (PSON1).....	10
1.8.7	LVDS/eDP Panel Voltage Selection (JLVDS1) .....	10
	Table 1.8: LVDS/eDP Panel Voltage Selection (JLVDS1) .....	10
1.8.8	COM1 RI# Pin RI#/5V/12V Select (JSETCOM1_V1) .....	11
	Table 1.9: COM1 RI# Pin RI#/5V/12V Select (JSETCOM1_V1)11	
1.8.9	JCASEOP_SW1: Case open selection pin header.....	11
	Table 1.10: JCASEOP_SW1: Case open selection pin header ..	11
1.8.10	JLVDS_VCON1: LVDS VESA, JEIDA format selection pin header 11	
	Table 1.11: JLVDS_VCON1: LVDS VESA, JEIDA format selection pin header.....	11
1.9	System Memory .....	12
1.10	Memory Installation Procedures.....	12
1.11	Cache Memory.....	12
1.12	Processor Installation.....	12
<b>Chapter 2</b>	<b>Connecting Peripherals .....</b>	<b>13</b>
2.1	Introduction .....	14
2.2	LAN + USB Ports (LAN1/2/3, USB12, USB34) .....	14
	Table 2.1: LAN LED Indicator.....	14

2.3	DP + HDMI Connector (DP1 + HDMI1) .....	15
2.4	Serial Ports (COM1~COM6) .....	15
2.5	PS/2 Keyboard and Mouse Connector (KBMS1) .....	16
2.6	CPU Fan Connector (CPU_FAN1) .....	16
2.7	System FAN Connector (SYSFAN1/2) .....	17
2.8	Power Switch/HDD LED/SMBUS/Speaker Pin Header (JFP1) & Power LED and Keyboard Lock Pin Header (JFP2) .....	17
2.8.1	ATX soft power switch (JFP1/PWR_SW) .....	17
2.8.2	Reset (JFP1/RESET).....	18
2.8.3	HDD LED (JFP1/HDDLED) .....	18
2.8.4	External speaker (JFP1/SPEAKER).....	18
2.8.5	Power LED and keyboard lock connector (JFP2/PWR_LED & KEY LOCK).....	18
	Table 2.2: ATX power supply LED status (No support for AT power) .....	18
2.9	ATX 12V Power Supply Connector (ATX12V1) & ATX Power Supply Connector (ATX_5VSB1).....	19
2.10	SATA Signal Connector (SATA1/2/3) .....	19
2.11	HD Analog Audio Interface (AUDIO1/2, FPAUD1) .....	20
2.12	PCI-E X4 Slot (PCIEX4_1).....	20
2.13	eDP/LVDS Panel Connector (LVDS_EDP1)(eDP support by BOM optional) .....	21
2.14	LVDS/eDP Backlight Inverter Power Connector (INV1).....	21
2.15	NGFF M.2 E-Key connector for 2230 module (M2E1).....	22
2.16	NGFF M.2 B-Key connector for 2242/3042 module (M2B1).....	22
2.17	HD Digital Audio Interface (SPDIF1).....	23
2.18	Audio Amplifier Output Connector (AMP1) .....	23
2.19	General Purpose I/O Pin Header (GPIO1).....	24
2.20	SPI BIOS Flash Socket (SPI1).....	24
2.21	SPI Programming Pin Header (SPI_CN1) .....	25
2.22	Low Pin Count Header (LPC1) .....	25
2.23	Case-Open Detect Connector (JCASE1).....	26
2.24	Battery Wafer Box (BAT1) .....	26
2.25	CPU Socket (CPU1) .....	27
2.26	DDR4 SO-DIMM Socket (DIMMA1, DIMMB1).....	27
2.27	SATA Power Connector (SATA_PWR1/2).....	28
2.28	DC Input Connector (DCIN1) .....	28

## Chapter 3 BIOS Operation ..... 29

3.1	Introduction .....	30
3.2	BIOS Setup .....	30
3.2.1	Main Menu .....	31
3.2.2	Advanced BIOS Features .....	32
3.2.3	Chipset Configuration Setting .....	65
3.2.4	Security.....	89
3.2.5	Boot Setting .....	90
3.2.6	Save & Exit Configuration.....	91

## Chapter 4 Software Introduction & Service ..... 93

4.1	Introduction .....	94
4.2	Value-Added Software Services .....	94
4.2.1	Software API.....	94
4.2.2	Software Utility.....	96

## Chapter 5 Chipset Software Installation Utility 97



5.1	Before You Begin .....	98
5.2	Introduction .....	98

## **Chapter 6**      **VGA Setup.....99**

6.1	Introduction .....	100
6.2	Windows 10 VGA Driver Installation .....	100

## **Chapter 7**      **LAN Configuration.....101**

7.1	Introduction .....	102
7.2	Features .....	102
7.3	Installation .....	102
7.4	Windows® 10 Driver Setup (Realtek 8111G & Intel i211AT) .....	102

## **Appendix A**      **I/O Pin Assignments.....103**

A.1	DC input Phoenix Connector (DCIN1) .....	104
A.2	Definition Multimedia Interface (DP1+HDMI1) .....	104
A.3	ATX Power supply (5VSB) connector (ATX_5VSB1).....	105
A.4	USB 3.0 Stack Connector (USB12) .....	105
A.5	USB 3.0 Stack Connector (USB34) .....	106
A.6	RJ45 2 Port (LAN12).....	106
A.7	Platform Controller Hub (PCH1).....	107
A.8	RJ45 1 Port (LAN1).....	107
A.9	SATA Signal Connector (SATA2) .....	108
A.10	RJ45 1 Port (LAN3).....	108
A.11	Battery Wafer Box (BAT1).....	109
A.12	HD Analog Audio Interface (AUDIO1).....	109
A.13	HD Analog Audio Interface (AUDIO2).....	109
A.14	Front HD Analog Audio Interface (FPAUD1).....	110
A.15	Audio Amplifier Output Connector (AMP1) .....	110
A.16	HD Digital Audio Interface (SPDIF1).....	110
A.17	SATA Signal Connector (SATA1) .....	111
A.18	PCI-E x4 Slot (PCIEX4_1) .....	111
A.19	NGFF M.2 E-Key connector for 2230 module (M2E1) .....	112
A.20	SATA Signal Connector (SATA3) .....	113
A.21	NGFF M.2 B-Key connector for 2242/3042 module (M2B1) .....	114
A.22	USB 2.0 Pin Header (USB56) .....	115
A.23	USB 2.0 Pin Header (USB78) .....	115
A.24	General Purpose I/O Pin Header (GPIO1).....	116
A.25	DDR4 SO-DIMM Socket (DIMMA1) .....	116
A.26	DDR4 SO-DIMM Socket (DIMMB1) .....	117
A.27	COM 4 Port (COM3456) .....	117
A.28	PS/2 Keyboard and Mouse Connector (KBMS1) .....	118
A.29	Low Pin Count Header (LPC1).....	118
A.30	COM 2 Port (COM12) .....	119
A.31	Power LED and Keyboard Lock Pin Header (JFP2) .....	119
A.32	Case-Open Detect Connector (JCASE1) .....	119
A.33	SPI Programming Pin Header (SPI_CN1) .....	120
A.34	SPI BIOS Flash Socket (SPI1).....	120
A.35	SYSTEM FAN Power Connector (SYSFAN1).....	120
A.36	SYSTEM FAN Power Connector (SYSFAN2).....	121
A.37	TI's SMBUS Programming for +Vcore/+VCCGT Controller (JSMB1) ...	121
A.38	LGA1151 CPU Socket H4 (CPU1).....	121
A.39	CPU FAN Power Connector (CPUFAN1) .....	122
A.40	LVDS Backlight Inverter Power Connector (INV1).....	122
A.41	SATA Power Connector (SATA_PWR2).....	122

---

A.42	SATA Power Connector (SATA_PWR1).....	123
A.43	eDP/LVDS Panel Connector (LVDS_EDP1).....	123
A.44	ATX 12V Power Supply Connector (ATX12V1) .....	124
A.45	SIM Card Connector (SIM1) .....	124
A.46	Buzzer (SP1).....	124
A.47	CPU Back Plate (CPU0_BACKPLATE1) .....	125

# Chapter 1

General Information

## 1.1 Introduction

AIMB-286 is designed with the Intel® H310 PCH for industrial applications that require both performance computing and enhanced power management capabilities. The motherboard supports Intel desktop Core i7/i5/i3/Pentium/Celeron processor up to 12 MB SmartCache and 2 DDR4 2666MHz SO-DIMM, up to 32 GB. A rich I/O connectivity of 6 x serial ports, 4 USB 3.0 + 4 USB 2.0, 3 GbE LAN, 3 SATA III, 1 NGFF (M.2\_E key) and 1 x NGFF (M.2\_B Key) Connector.

## 1.2 Features

- **Rich I/O connectivity:** 6 x serial ports, 4 x USB 3.0, 4 x USB 2.0, 3 x SATAIII, 1 M.2 B key & 1 M.2 E key, 3 GbE LAN and 1 PCIe x 4
- **Standard Mini-ITX form factor with industrial feature:** The AIMB-286 is a full-featured Mini-ITX motherboard with balanced expandability and performance
- **Wide selection of storage devices:** SATA HDD, M.2 (B key), customers benefit from the flexibility of using the most suitable storage device for larger capacity
- **Optimized integrated graphic solution:** With Intel® Graphics Flexible, it supports versatile display options and 32/64 bit 3D graphics engine

## 1.3 Specifications

### 1.3.1 System

- **CPU:** LGA1151 Intel desktop Core i7/i5/i3/Pentium/Celeron processors compliant
- **BIOS:** AMI EFI 128 Mbit SPI BIOS
- **System chipset:** Intel® H310
- **SATA hard disk drive interface:**
  - Three on-board SATA connector with data transmission rate up to 600 MB
  - One M.2 B key for storage with data transmission rate up to 600 MB

### 1.3.2 Memory

- **RAM:** 2 x 260-pins SODIMM socket support dual channel DDR4 2666MHz SDRAM, up to 32GB Max.

### 1.3.3 Input/Output

- **PCI bus:** 1 x PCIe x4 slot
- **Serial ports:** Six serial ports; COM1/4/5/6: RS-232, COM2/3: RS-232/422/485 (RS-422/485 supports by BOM option)
- **Keyboard and PS/2 mouse connector:** Supports one standard PS/2 keyboard, one standard PS/2 mouse
- **USB port:** Supports four USB 3.0 port with a transmission rate of up to 5Gbps and four USB 2.0 ports with transmission rates of up to 480 Mbps.

**Note!** *USB 3.0 for USB4 is only available when M.2 B key USB 3.0 is not in use; USB 3.0 for USB4 and M.2 B key USB 3.0 cannot be used concurrently.*



- **GPIO connector:** 16-bit general purpose Input/Output

### 1.3.4 Graphics

- **Controller:** Intel® HD graphics
- **Display memory:** 512 MB maximum shared memory with 2GB and above system memory installed
- **LVDS:** Supports dual channel 24-bit up to 1920 x 1200 @ 60Hz
- **HDMI1.4:** Supports max. resolution 4096 x 2160 @ 24Hz
- **Displayport1.2:** Supports DP++ up to 4096 x 2304 @ 60Hz
- **eDP:** Supports up to resolution 4096 x 2304 @ 60Hz (eDP is colay with LVDS, and support by BOM optional)

### 1.3.5 Ethernet LAN

- Supports dual 10/100/1000 Mbps Ethernet port (s) via PCI Express x1 bus which provides 500 MB/s data transmission rate
- **Controller:** LAN1/2: Realtek RTL8111G; LAN3: Intel i211AT

### 1.3.6 Industrial features

- **Watchdog timer:** Can generate a system reset. The watchdog timer is programmable, with each unit equal to one second or one minute (255 levels)

### 1.3.7 Mechanical and environmental specifications

- **Operating temperature:** 0 ~ 60° C (32 ~ 140° F, Depending on CPU)
- **Storage temperature:** -40 ~ 85° C (-40 ~ 185° F)
- **Humidity:** 5 ~ 95% non-condensing
- **Power supply voltage:** +12V
- **Power consumption:**  
Intel Core i7-8700 3.2GHz, 2pcs 16GB DDR4 2666MHz SDRAM, +12V @ 11.095A  
Measure the maximum current value which system under maximum load (CPU: Top speed, RAM & Graphic: Full loading)
- **Board size:** 170 mm x 170 mm (6.69" x 6.69")
- **Board weight:** 0.365 kg

## 1.4 Jumpers and Connectors

Connectors on the AIMB-286 motherboard link it to devices such as hard disk drives and a keyboard. In addition, the board has a number of jumpers used to configure your system for your application.

The tables below list the function of each of the board jumpers and connectors. Later sections in this chapter give instructions on setting jumpers. Chapter 2 gives instructions for connecting external devices to your motherboard.

**Table 1.1: Connector and Header List**

	<b>Description</b>	<b>Location Name</b>
1	DC input Phoenix Connector	DCIN1
2	DisplayPort	DP1+HDMI1
3	High Definition Multimedia Interface	DP1+HDMI1
4	ATX Power supply (5VSB) connector	ATX_5VSB1
5	USB 3.0 Stack Connector	USB12
6	USB 3.0 Stack Connector	USB34
7	RJ45 2 port	LAN12
8	Platform Controller Hub	PCH1
9	SATA Signal Connector	SATA1/2/3
10	RJ45 1 port	LAN3
11	Battery Wafer Box	BAT1
12	HD Analog Audio Interface: Line-Out	AUDIO1
13	HD Analog Audio Interface: MIC	AUDIO2
14	Front HD Analog Audio Interface	FPAUD1
15	Audio Amplifier Output Connector	AMP1
16	HD Digital Audio Interface	SPDIF1
17	PCI-E x 4 Slot	PCIEX4_1
18	NGFF M.2 E-Key connector for 2230 module	M2E1
19	NGFF M.2 B-Key connector for 2242/3042 module	M2B1
20	USB 2.0 Connector	USB56/USB78
21	General Purpose I/O Pin Header	GPIO1
22	DDR4 SO-DIMM Socket	DIMMA1/DIMMB1
23	COM 4 Port	COM3456
24	PS/2 Keyboard and Mouse Connector	KBMS1
25	Low Pin Count Header	LPC1
26	COM 2 Port	COM12
27	Power LED and Keyboard Lock Pin Header	JFP2
28	Case-Open Detect Connector	JCASE1
29	SPI Programming Pin Header	SPI_CN1
30	SPI BIOS Flash Socket	SPI1
31	SYSTEM FAN Power Connector	SYSFAN1/SYSFAN2
32	TI's SMBUS Programming for +Vcore/+VCCGT Controller	JSMB1
33	LGA1151 CPU Socket H4	CPU1
34	CPU FAN Power Connector	CPUFAN1
35	eDP/LVDS Backlight Inverter Power Connector	INV1
36	SATA Power Connector	SATA_PWR1/ SATA_PWR2
37	eDP/LVDS Panel Connector	LVDS_EDP1
38	ATX 12V Power Supply Connector	ATX12V1
39	SIM Card Connector	SIM1
40	Buzzer	SP1
41	CPU Back Plate	CPU0_BACKPLATE1

**Table 1.2: Jumper List**

	Description	Location Name
1	LVDS VESA, JEIDA format selection pin header	JLVDS_VCON1
2	CMOS Clear Jumper	JCMOS1
3	Watchdog Timer Output and OBS Beep	JWDT1+JOBS1
4	COM1 RI# pin RI#/5V/12V Select	JSETCOM1_V1
5	Power Switch/HDD LED/SMBUS/Speaker Pin Header	JFP1
6	Case open selection pin header	JCASEOP_SW1
7	ATX/AT Mode Selection	PERSON1
8	eDP/LVDS Panel Voltage Selection	JLVDS1

## 1.5 Board layout: Jumper and Connector Locations

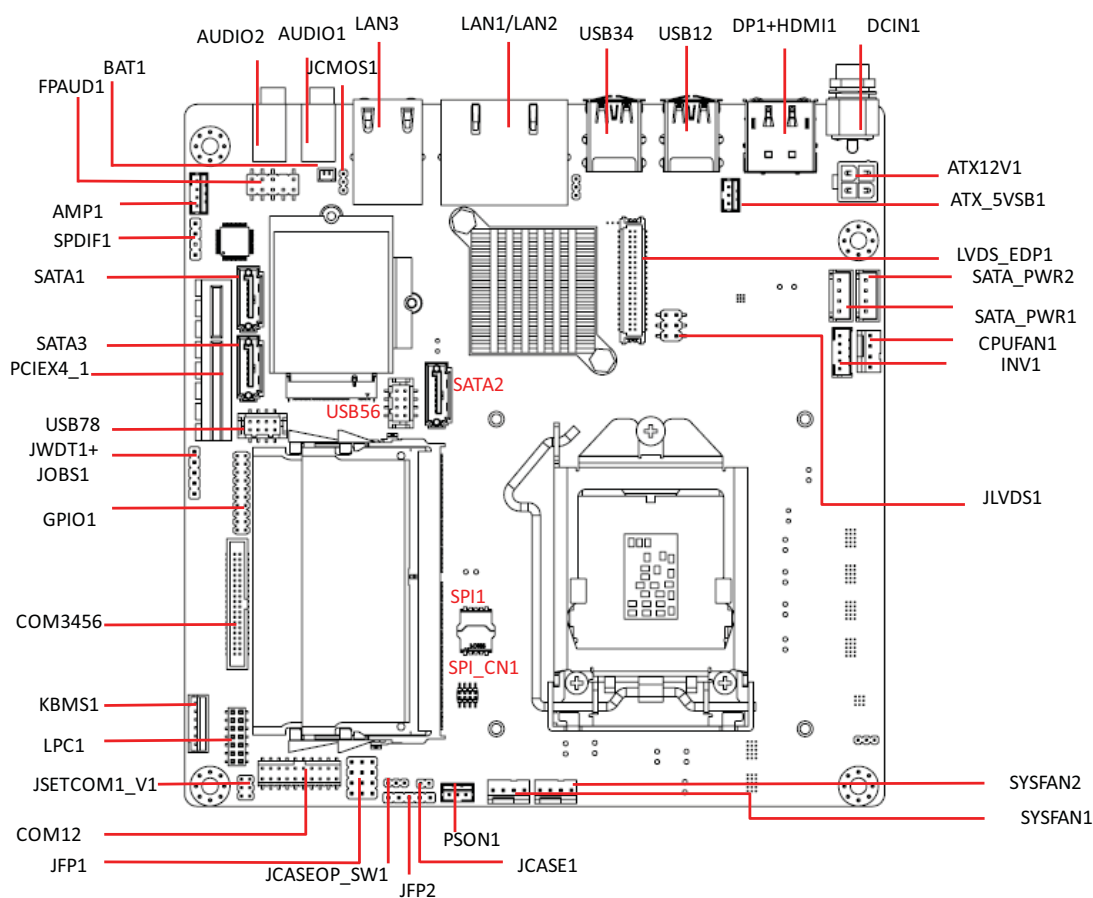
**Figure 1.1 Jumper and Connector Location (Top Side)**

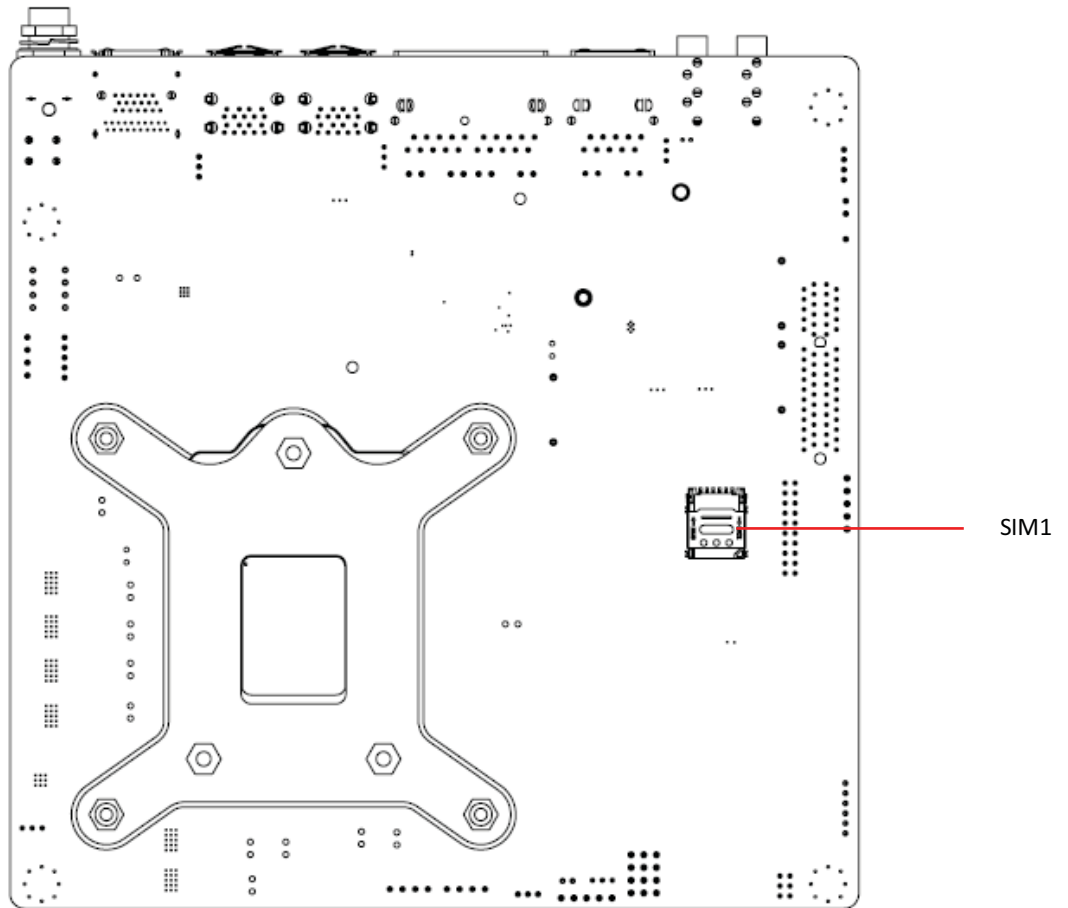

**Figure 1.2 Jumper and Connector Location (Bottom Side)**



## 1.6 AIMB-286 Board Diagram

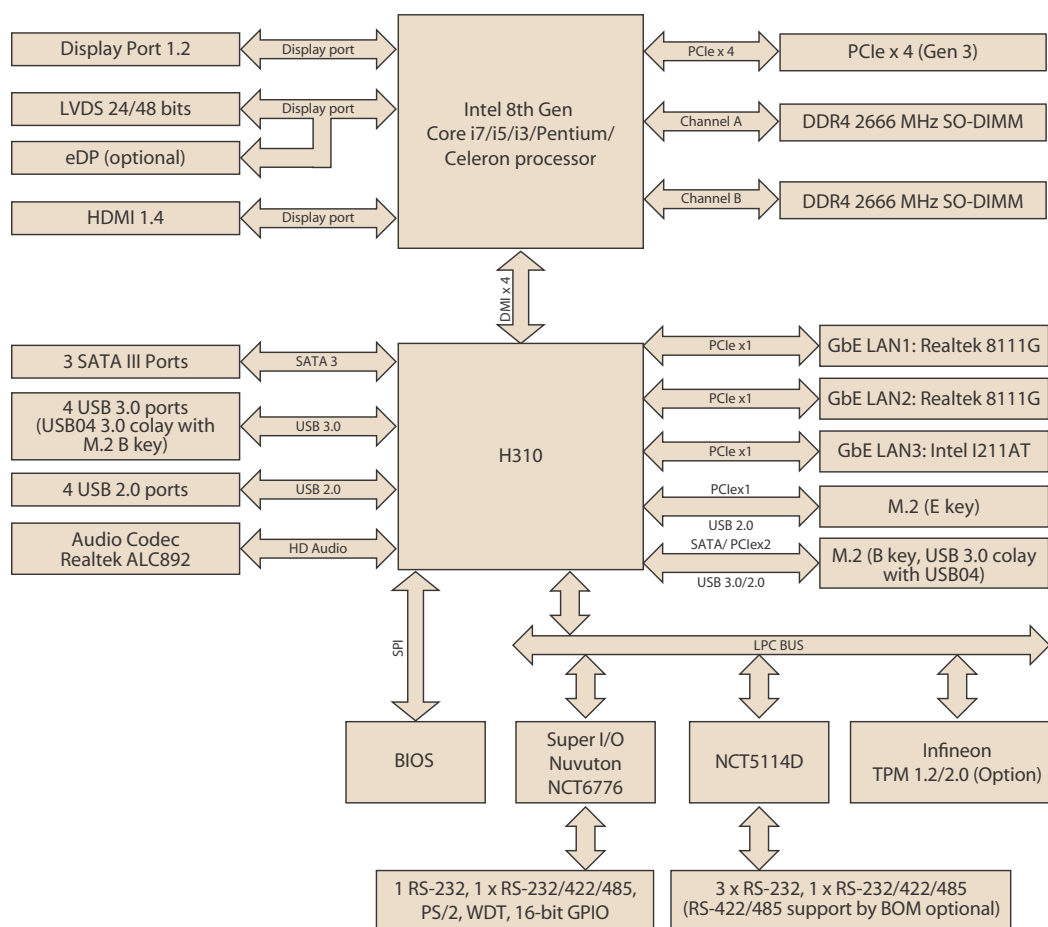

Figure 1.3 AIMB-286 Board Diagram

## 1.7 Safety Precautions

**Warning!** Always completely disconnect the power cord from chassis whenever you work with the hardware. Do not make connections while the power is on. Sensitive electronic components can be damaged by sudden power surges. Only experienced electronics personnel should open the PC chassis.



**Caution!** Always ground yourself to remove any static charge before touching the motherboard. Modern electronic devices are very sensitive to electrostatic discharges. As a safety precaution, use a grounding wrist strap at all times. Place all electronic components on a static-dissipative surface or in a static-shielded bag when they are not in the chassis.



**Caution!** The computer is provided with a battery-powered real-time clock circuit. There is a danger of explosion if battery is incorrectly replaced. Replace only with same or equivalent type recommended by the manufacturer. Discard used batteries according to manufacturer's instructions.



**Caution!** *There is a danger of a new battery exploding if it is incorrectly installed. Do not attempt to recharge, force open, or heat the battery. Replace the battery only with the same or equivalent type recommended by the manufacturer. Discard used batteries according to the manufacturer's instructions.*



## 1.8 Jumper Settings

This section provides instructions on how to configure your motherboard by setting the jumpers. It also includes the motherboards's default settings and your options for each jumper.

### 1.8.1 How to Set Jumpers

You can configure your motherboard to match the needs of your application by setting the jumpers. A jumper is a metal bridge that closes an electrical circuit. It consists of two metal pins and a small metal clip (often protected by a plastic cover) that slides over the pins to connect them. To “close” (or turn ON) a jumper, you connect the pins with the clip. To “open” (or turn OFF) a jumper, you remove the clip. Sometimes a jumper consists of a set of three pins, labeled 1, 2, and 3. In this case you connect either pins 1 and 2, or 2 and 3. A pair of needle-nose pliers may be useful when setting jumpers.

### 1.8.2 CMOS Clear (JCMOS1)

The AIMB-286 motherboard contains a jumper that can erase CMOS data and reset the system BIOS information. Normally this jumper should be set with pins 1-2 closed. If you want to reset the CMOS data, set CMOS1 to 2-3 closed for just a few seconds, and then move the jumper back to 1-2 closed. This procedure will reset the CMOS to its default setting.

**Table 1.3: CMOS1**

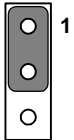
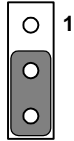
Function	Jumper Setting
Keep CMOS data (Default)	 <span style="margin-left: 5px;">1</span> <span style="margin-left: 100px;">1-2 closed</span>
Clear CMOS data	 <span style="margin-left: 5px;">1</span> <span style="margin-left: 100px;">2-3 closed</span>

### 1.8.3 Power Switch/HDD LED/SMBUS/Speaker Pin Header (JFP1)

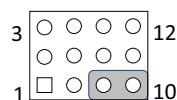

**Table 1.4: Power Switch/HDD LED/SMBUS/Speaker Pin Header (JFP1)**

Pin	Signal	Pin	Signal
1	+5V	2	HDDLED+
3	Power Button+	4	NC
5	HDDLED-	6	Power Button-
7	SPK_P3	8	SMB_DATA
9	System Reset+	10	SPK_P4
11	SMB_CLK	12	System Reset-

### 1.8.4 Power LED and Keyboard Lock Pin Header (JFP2)

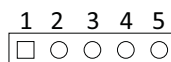

**Table 1.5: Power LED and Keyboard Lock Pin Header (JFP2)**

Pin	Signal
1	LED Power
2	NC
3	GND
4	Keyboard LOCK#
5	GND

### 1.8.5 Watchdog Timer Output and OBS Beep (JWDT1+JOBS1)

**Table 1.6: Watchdog Timer Output and OBS Beep (JWDT1+JOBS1)**

Function	Jumper Setting
Watchdog Timer Output(2-3) (Default) OBS BEEP(4-5) (Default)	<p>(2 and 3)+(4 and 5)</p>
Watchdog Timer Disable (1-2) OBS BEEP(4-5) (Default)	<p>(1 and 2)+(4 and 5)</p>

## 1.8.6 ATX/AT Mode Selection (PSON1)

**Table 1.7: ATX/AT Mode Selection (PSON1)**

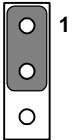
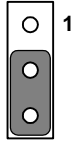
Function	Jumper Setting
AT Mode	 1-2 closed
ATX Mode (Default)	 2-3 closed

## 1.8.7 LVDS/eDP Panel Voltage Selection (JLVDS1)

**Table 1.8: LVDS/eDP Panel Voltage Selection (JLVDS1)**

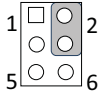
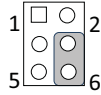
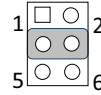
Function	Jumper Setting
Jumper position for 5V	 JLVDS1 (2-4)
Jumper position for 3.3V (Default)	 JLVDS1 (4-6)
Jumper position for 12V	 JLVDS1 (3-4)

### 1.8.8 COM1 RI# Pin RI#/5V/12V Select (JSETCOM1\_V1)

**Table 1.9: COM1 RI# Pin RI#/5V/12V Select (JSETCOM1\_V1)**

Function	Jumper Setting
Jumper position for RI#(Default)	<p>1 and 2</p>
Jumper position for 5V	<p>3 and 4</p>
Jumper position for 12V	<p>5 and 6</p>

### 1.8.9 JCASEOP\_SW1: Case open selection pin header

**Table 1.10: JCASEOP\_SW1: Case open selection pin header**

Function	Jumper Setting
Normal Open	
Normal Close (Default)	

### 1.8.10 JLVDV\_VCON1: LVDS VESA, JEIDA format selection pin header

**Table 1.11: JLVDV\_VCON1: LVDS VESA, JEIDA format selection pin header**

Function	Jumper Setting
JEIDA mode (HI=+3.3V)	
VESA mode (Low=0V) (Default)	

---

## 1.9 System Memory

AIMB-286 has two sockets for a 260 pins DDR4 SO-DIMM. This socket uses a 1.2 V unbuffered double data rate synchronous DRAM (DDR SDRAM). DRAM is available in capacities of 4GB, 8GB and 16GB. The sockets can be filled in any combination with SODIMMs of any size, giving a total memory size between 4GB, 8GB, 16GB, and up to max 32GB. AIMB-286 does NOT support error checking and correction (ECC).

## 1.10 Memory Installation Procedures

To install SODIMMs, first make sure the two handles of the SODIMM socket are in the “open” position, i.e., the handles lean outward. Slowly slide the SODIMM module along the plastic guides on both ends of the socket. Then firmly but gently (avoid pushing down too hard) press the SODIMM module well down into the socket, until you hear a click when the two handles have automatically locked the memory module into the correct position of the SODIMM socket. To remove the memory module, just push both handles outward, and the memory module will be ejected by the mechanism.

## 1.11 Cache Memory

The AIMB-286 supports a CPU with one of the following built-in full speed last level cache:

12MB for Intel Core i7-8700/ i7-8700T

9MB for Intel Core i5-8500/ i5-8500T

6MB for Intel Core i3-8100/ i3-8100T

4MB for Pentium G5400/ G5400T

2MB for Celeron G4900/ G4900T

The built-in second-level cache in the processor yields much higher performance than conventional external cache memories.

## 1.12 Processor Installation

The AIMB-286 is designed to supported Intel 8th Gen LGA1151, Core i7/Core i5/ Core i3, Pentium, Celeron processor.

# Chapter 2

Connecting  
Peripherals

## 2.1 Introduction

You can access most of the connectors from the top of the board as it is being installed in the chassis. If you have a number of cards installed or have a packed chassis, you may need to partially remove the card to make all the connections.

## 2.2 LAN + USB Ports (LAN1/2/3, USB12, USB34)

The AIMB-286 provides up to 8 USB ports. There are 4 x USB 3.0 on the rear side and 4 x USB 2.0 pin header on the board. The USB interface complies with the USB specification revision 2.0 that supports transmission rates of up to 480 Mbps, revision 3.0 that supports transmission rates of up to 5 Gbps, and is also fuse protected. Furthermore, the USB interface can be disabled in the system BIOS setup menu.

The AIMB-286 is equipped with three high-performance 1000 Mbps Ethernet LAN adapter, which are supported by all major network operating systems. The RJ-45 jacks on the rear panel provides for convenient LAN connection.

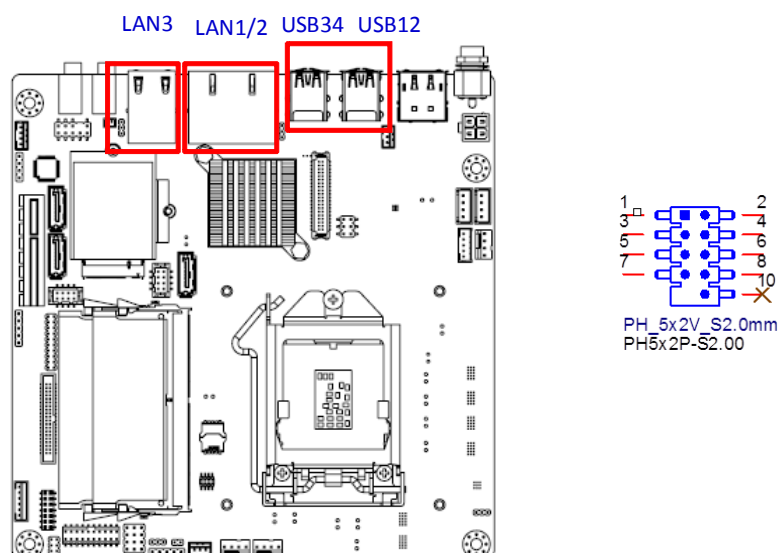
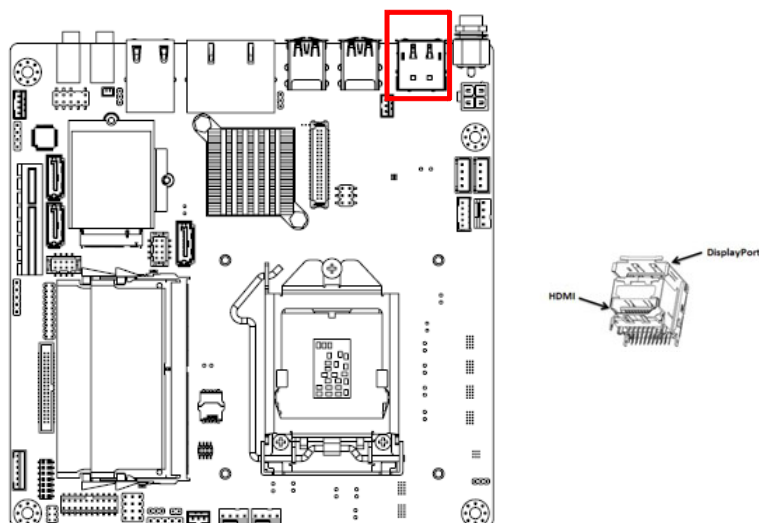

**Table 2.1: LAN LED Indicator**

LAN Mode	LAN Indicator	
LAN1/LAN2/LAN3 indicator	LED1 (Right)	off for mal-link; Link (On) / Active (Flash)
	LED2 (Left)	100 Mbps (On) / 10 Mbps (Off); Color: Orange (10/100 Mbps)
	LED2 (Left)	1000 Mbps (On); Color: Green (1000 Mbps)



## 2.3 DP + HDMI Connector (DP1 + HDMI1)



## 2.4 Serial Ports (COM1~COM6)

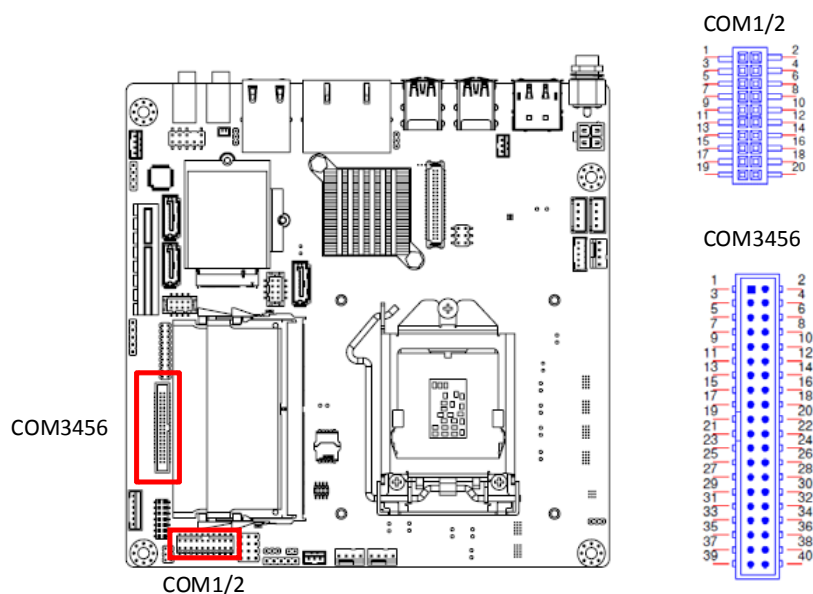

AIMB-286 supports six serial ports, COM1/4/5/6 support RS-232 function, COM2/3 support RS-232/422/485 function (RS422/485 support by BOM optional). These ports can connect to serial devices, such as a mouse or a printer, or to a communications network. The IRQ and address ranges for these ports are fixed. However, if you want to disable the port or change these parameters later, you can do this in the system BIOS setup. Different devices implement the RS-232 standards in different ways. If you have problems with a serial device, be sure to check the pin assignments for the connector.

## 2.5 PS/2 Keyboard and Mouse Connector (KBMS1)

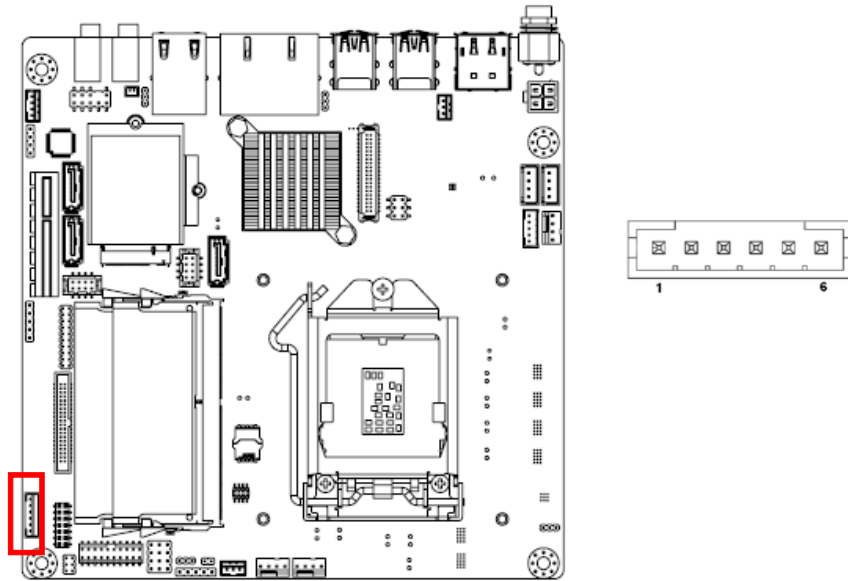

On board 6-pin wafer box connector, supports one standard PS/2 keyboard, one standard PS/2 mouse.

## 2.6 CPU Fan Connector (CPU\_FAN1)

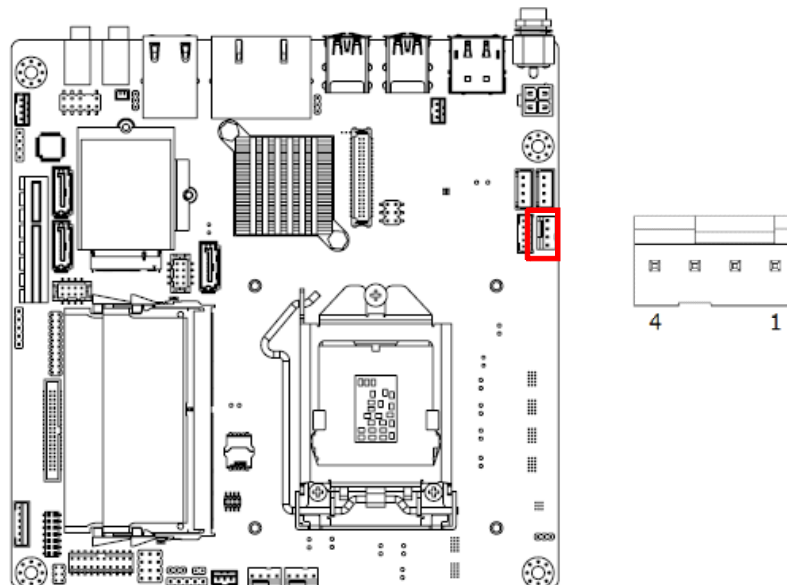

If a fan is used, this connector supports cooling fans of 500 mA (6 W) or less.

## 2.7 System FAN Connector (SYSFAN1/2)

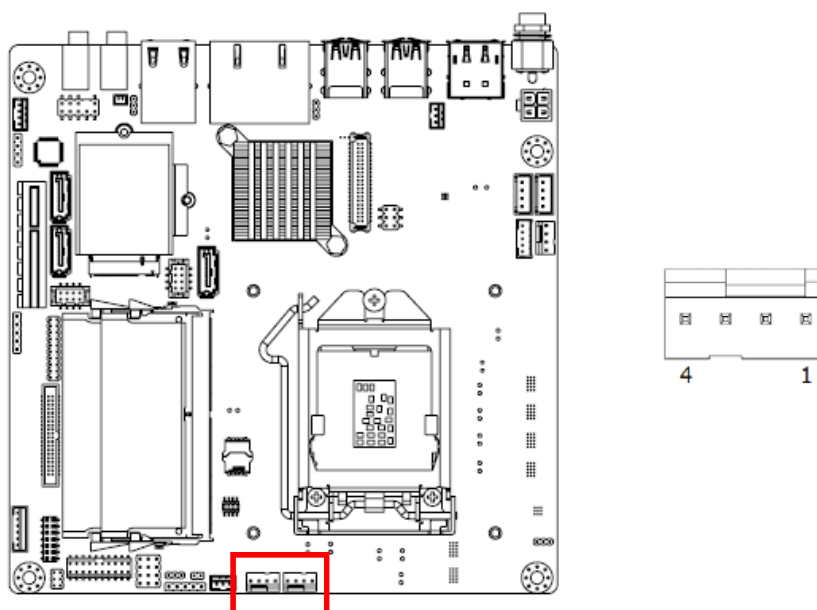

If a fan is used, this connector supports cooling fans of 500 mA (6 W) or less.

## 2.8 Power Switch/HDD LED/SMBUS/Speaker Pin Header (JFP1) & Power LED and Keyboard Lock Pin Header (JFP2)

There are several headers for monitoring and controlling the AIMB-286.

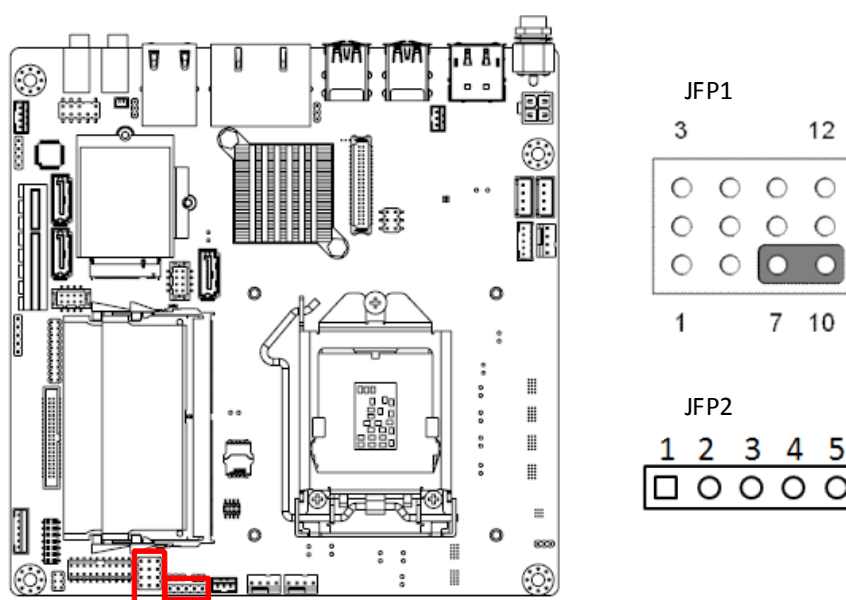

### 2.8.1 ATX soft power switch (JFP1/PWR\_SW)

If your computer case is equipped with an ATX power supply, you should connect the power on/off button on your computer case to (JFP1/ PWR\_SW), for convenient power on and off.

## 2.8.2 Reset (JFP1/RESET)

Many computer cases offer the convenience of a reset button. Connect the wire for the reset button.

## 2.8.3 HDD LED (JFP1/HDDLED)

You can connect an LED to connector (JFP1/HDDLED) to indicate when the HDD is active.

## 2.8.4 External speaker (JFP1/SPEAKER)

JFP1/SPEAKER is a 4-pin connector for an external speaker. If there is no external speaker, the AIMB-286 provides an onboard buzzer as an alternative. To enable the buzzer, set pins 7 & 10 as closed.

## 2.8.5 Power LED and keyboard lock connector (JFP2/PWR\_LED & KEY LOCK)

(JFP2/PWR\_LED & KEY LOCK) is a 5-pin connector for the power on LED and Key Lock function. Refer to Appendix B for detailed information on the pin assignments. The Power LED cable should be connected to pin 1-3. The key lock button cable should be connected to pin 4-5. There are 3 modes for the power supply connection. The first is “ATX power mode”; the system turns on/off by a momentary power button. The second is “AT Power Mode”; the system turns on/off via the power supply switch. The third is another “AT Power Mode” which makes use of the front panel power switch. The power LED status is indicated in the following table:

**Table 2.2: ATX power supply LED status (No support for AT power)**

Power mode	LED (ATX Power Mode) (On/off by momentary button)	LED (AT power Mode) (On/off by switching power supply)	LED (AT power Mode) (On/off by front panel switch)
PSON1 (on back plane) jumper setting	pins 2-3 closed	pins 1-2 closed	Connect pins 1 & 2 to panel switch via cable
System On	On	On	On
System Off	Off ( Windows 7) Slow Flashes (Window 8)	Off	Off
System Suspend (S3)	Fast Flashes	NA	NA
System Suspend (S4)	Slow Flashes	NA	NA

## 2.9 ATX 12V Power Supply Connector (ATX12V1) & ATX Power Supply Connector (ATX\_5VSB1)

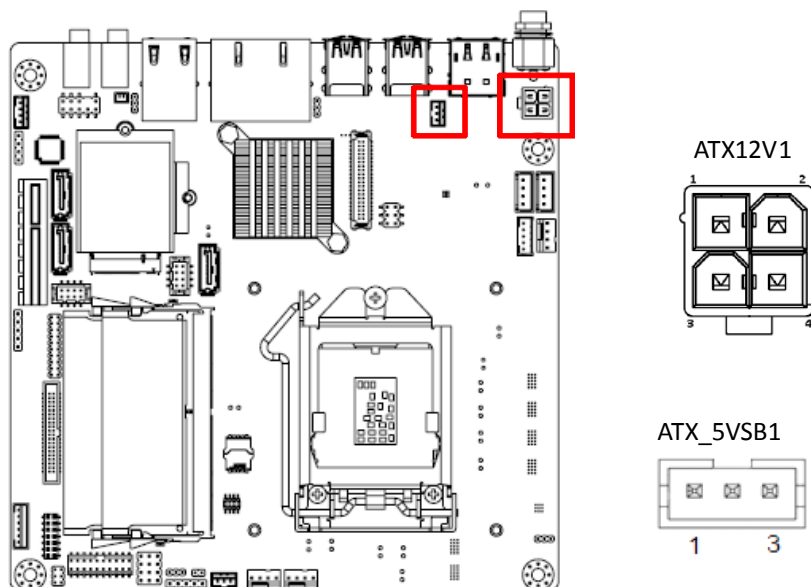

## 2.10 SATA Signal Connector (SATA1/2/3)

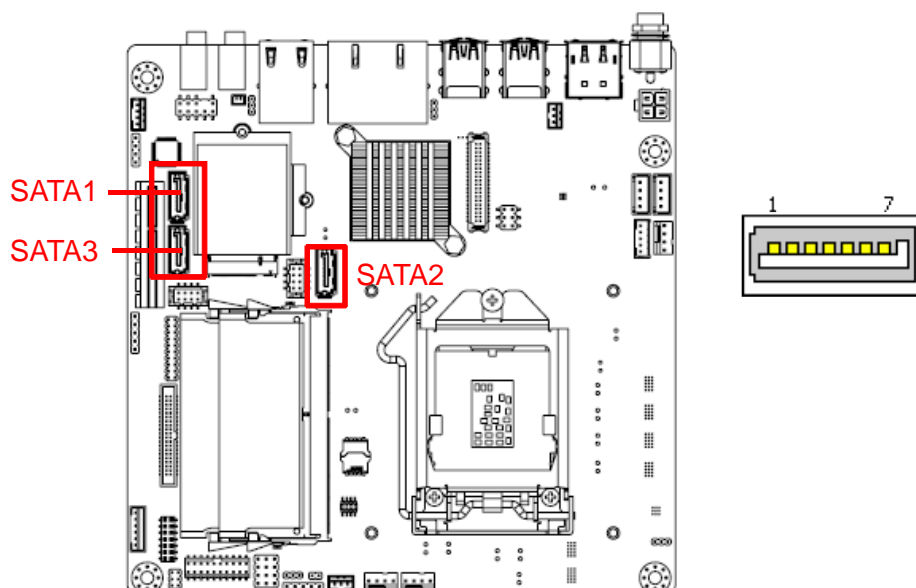

AIMB-286 features a high performance Serial ATA III interface (up to 600 MB/s) which eases hard drive cabling with thin, space-saving cables.

## 2.11 HD Analog Audio Interface (AUDIO1/2, FPAUD1)

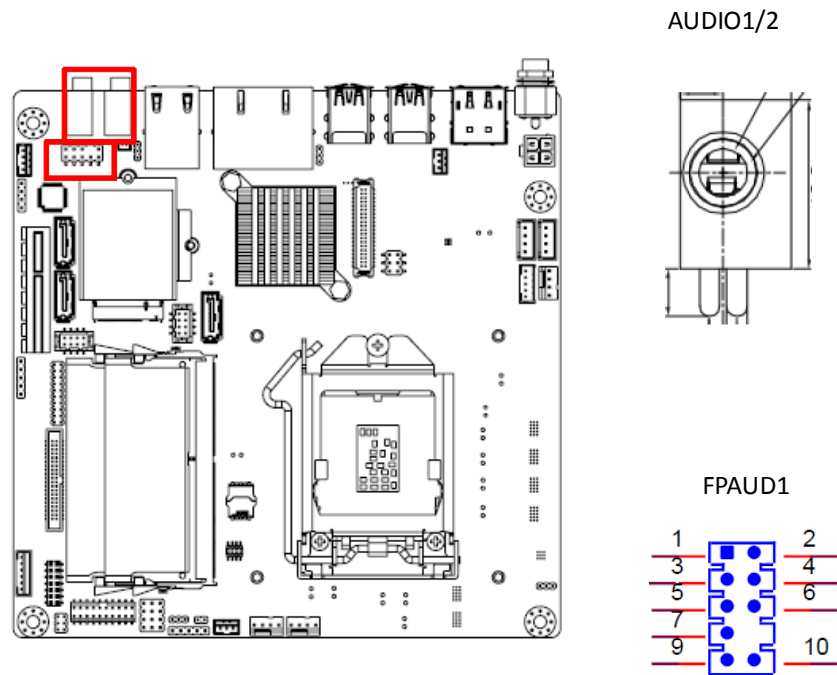

## 2.12 PCI-E X4 Slot (PCIEX4\_1)

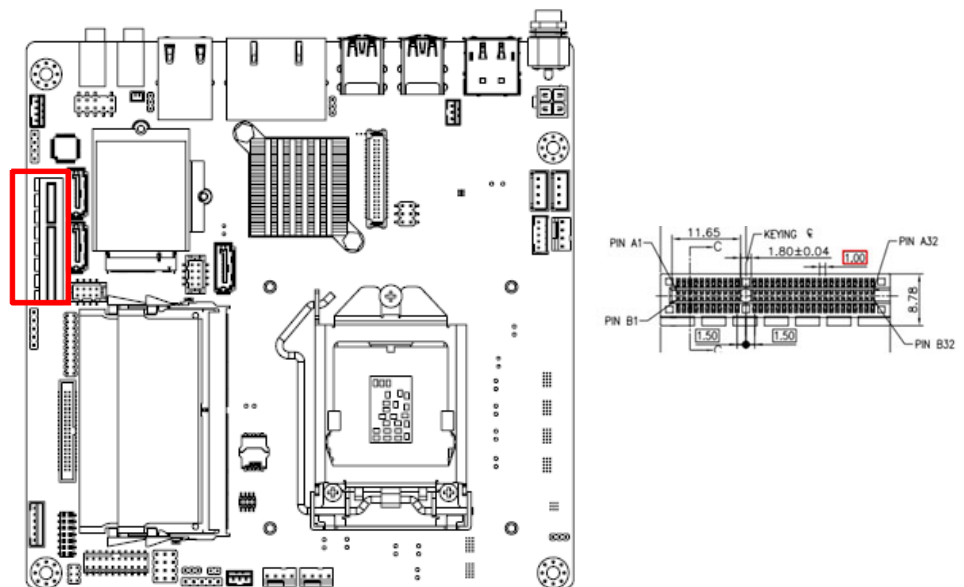

## 2.13 eDP/LVDS Panel Connector (LVDS\_EDP1)(eDP support by BOM optional)

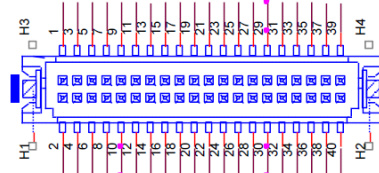
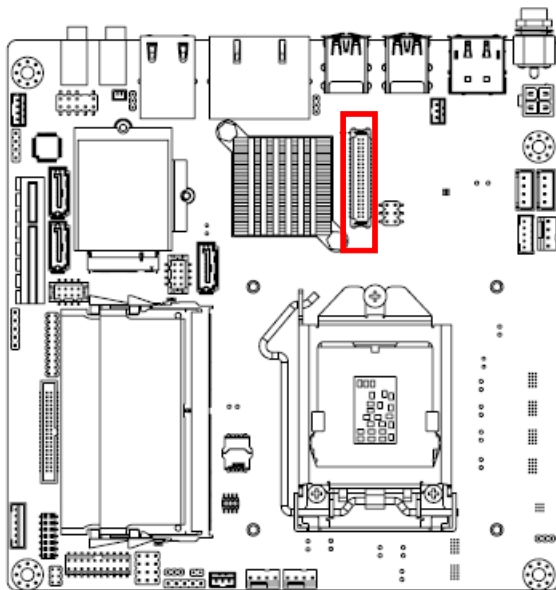

### LVDS1

Pin 3: GND -> Panel connected  
 NC/3.3V -> No panel

## 2.14 LVDS/eDP Backlight Inverter Power Connector (INV1)

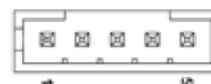
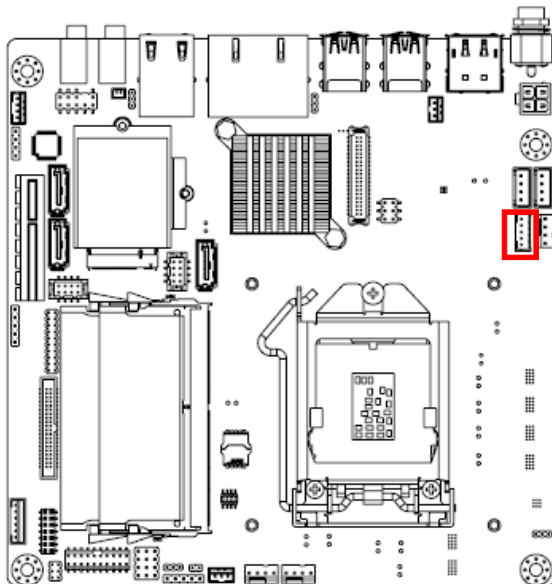

**Note!** ■ **Signal Description**



**Signal**

VR

ENBKL

**Signal Description**

Vadj=0.75 V

(Recommended: 4.7 K $\Omega$ , >1/16 W)

LCD backlight ON/OFF control signal)

## 2.15 NGFF M.2 E-Key connector for 2230 module (M2E1)

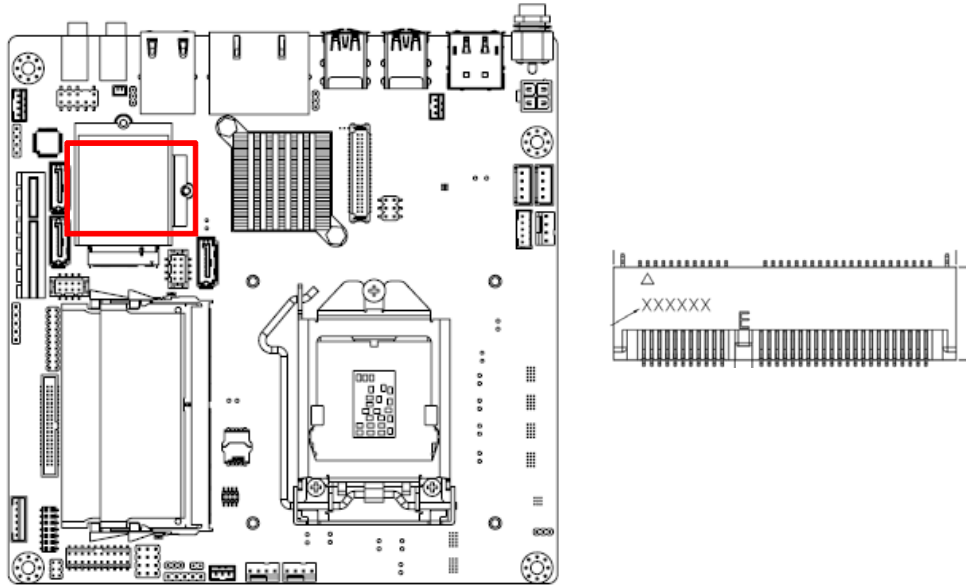

## 2.16 NGFF M.2 B-Key connector for 2242/3042 module (M2B1)

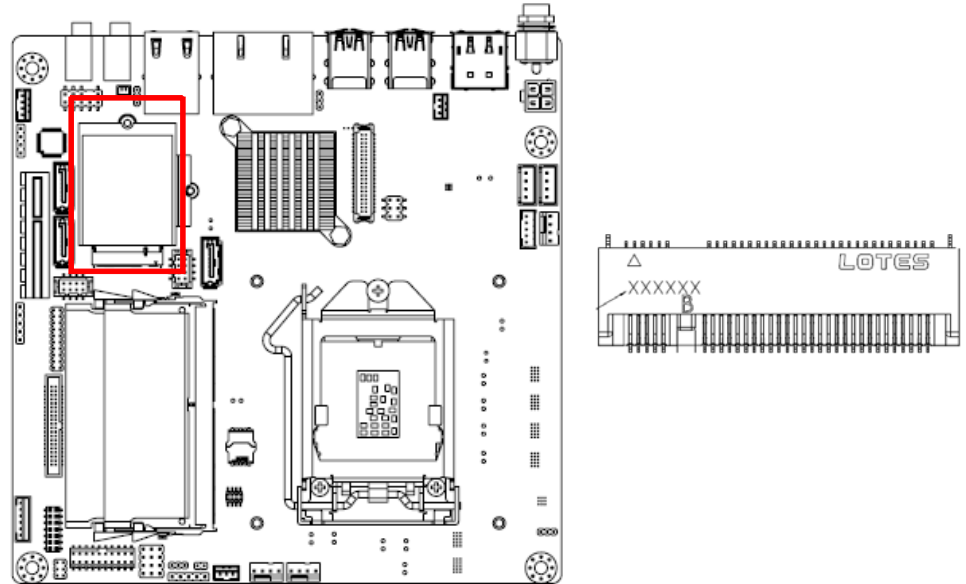



## 2.17 HD Digital Audio Interface (SPDIF1)

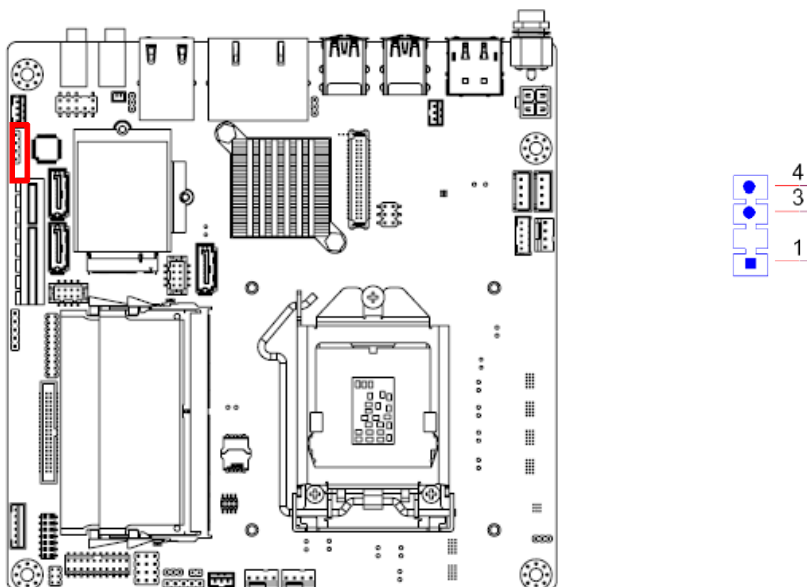

## 2.18 Audio Amplifier Output Connector (AMP1)

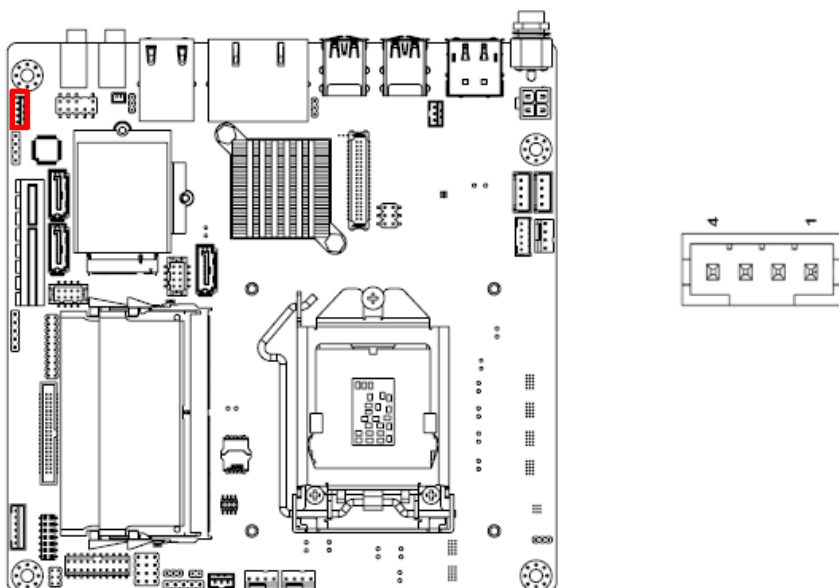

## 2.19 General Purpose I/O Pin Header (GPIO1)

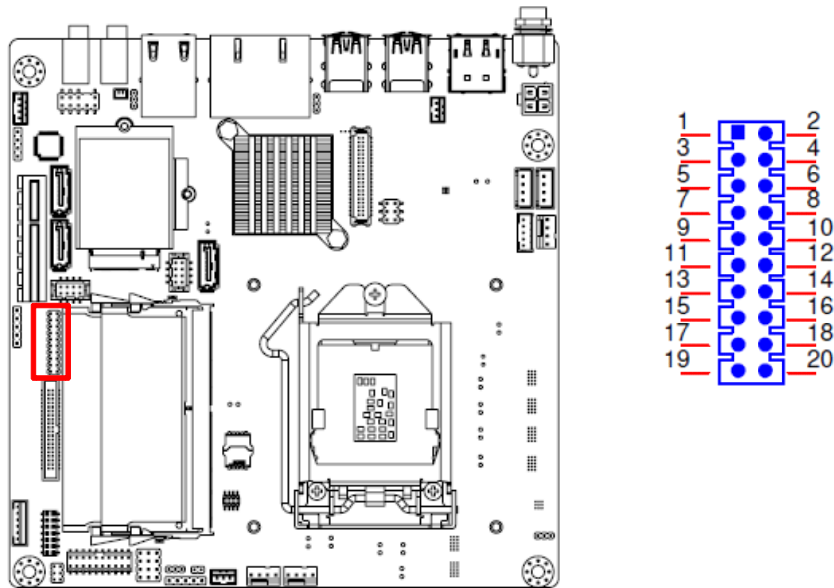

## 2.20 SPI BIOS Flash Socket (SPI1)

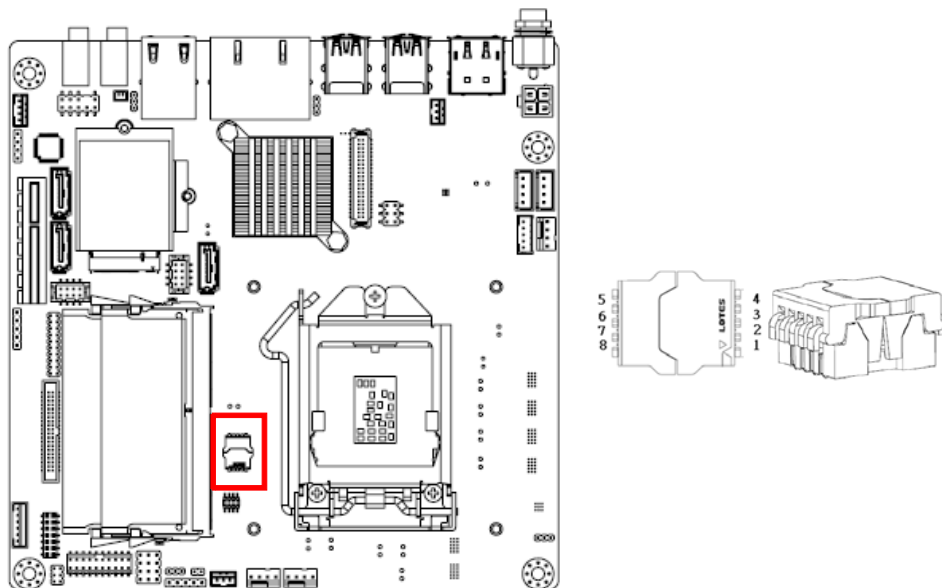

## 2.21 SPI Programming Pin Header (SPI\_CN1)

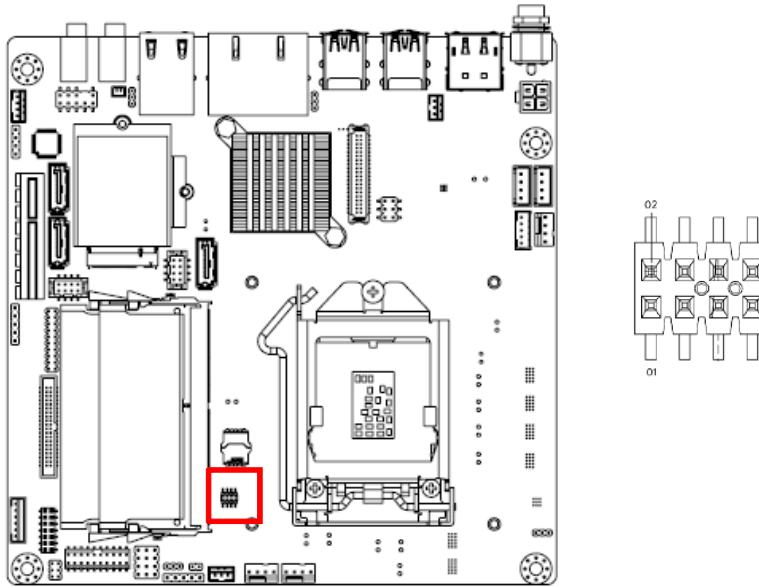

## 2.22 Low Pin Count Header (LPC1)

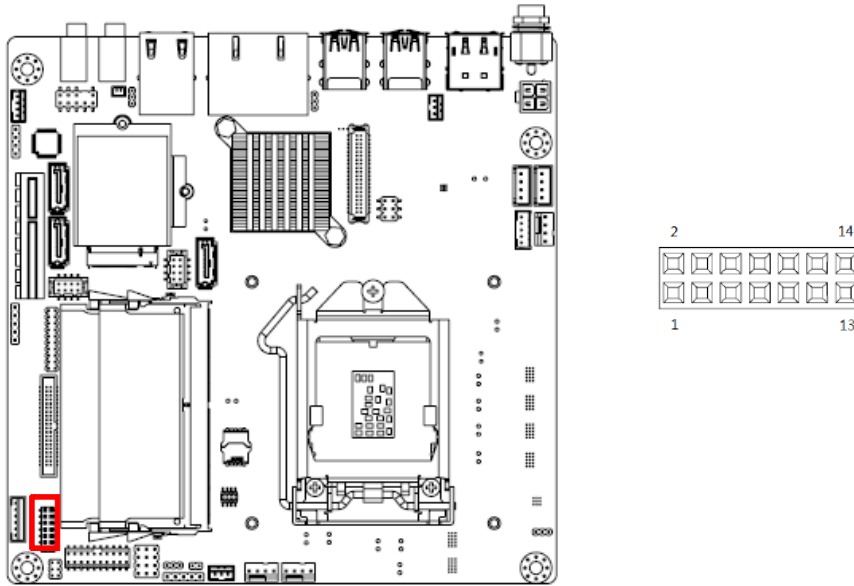

## 2.23 Case-Open Detect Connector (JCASE1)

The SPI flash card pin header may be used to flash BIOS if the AIMB-286 cannot power on.

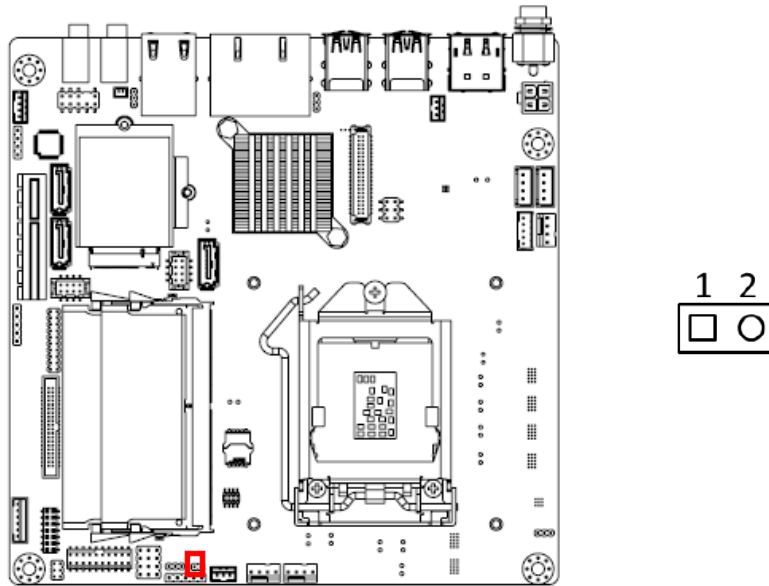

## 2.24 Battery Wafer Box (BAT1)

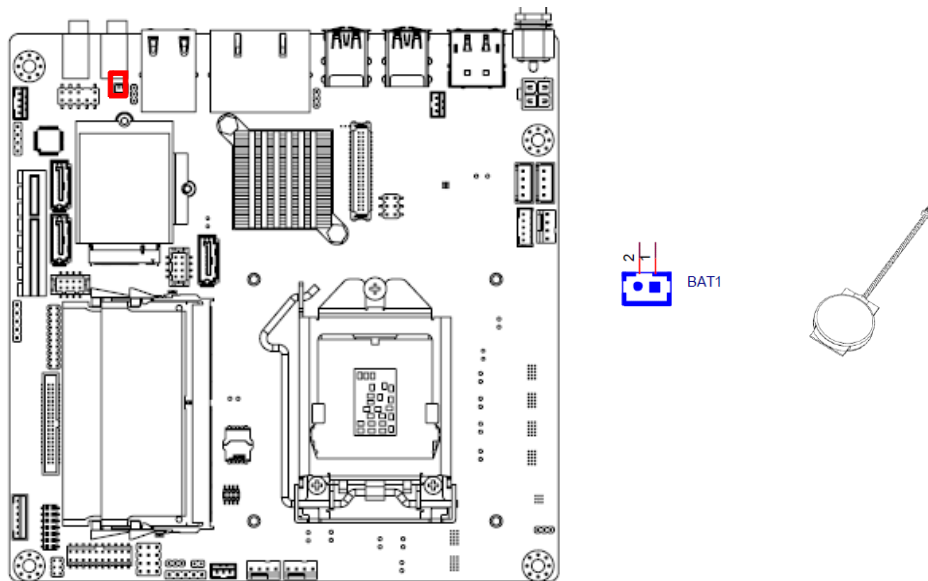

## 2.25 CPU Socket (CPU1)

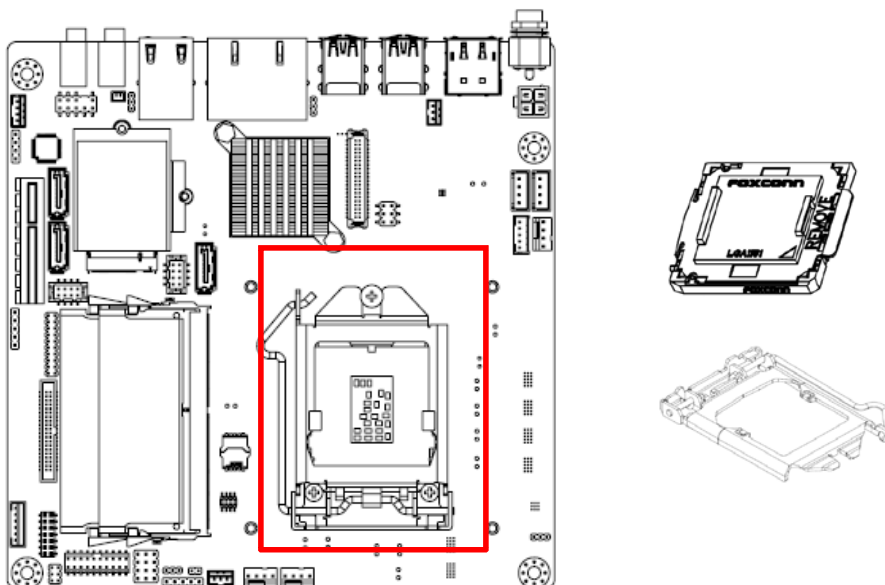

## 2.26 DDR4 SO-DIMM Socket (DIMMA1, DIMMB1)

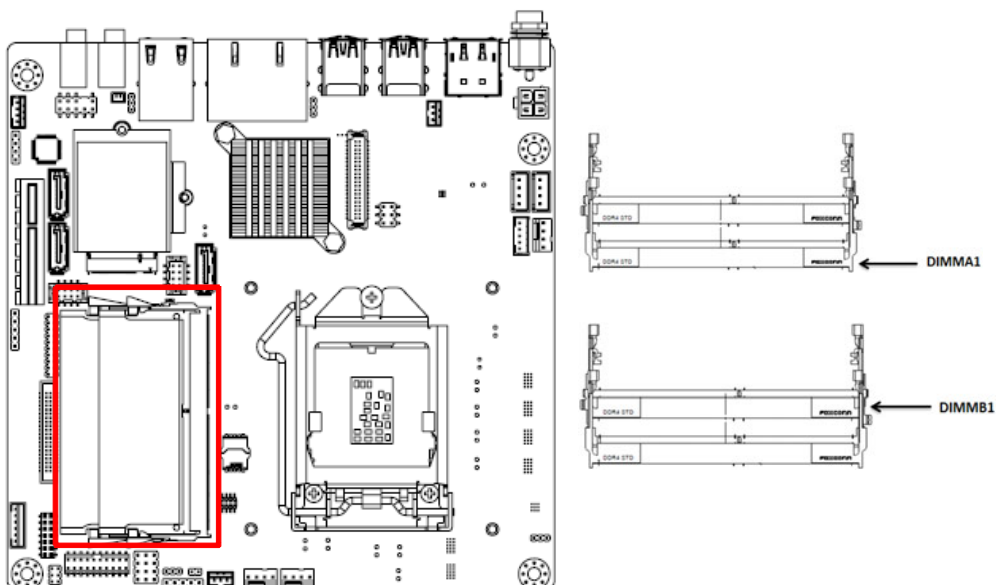

## 2.27 SATA Power Connector (SATA\_PWR1/2)

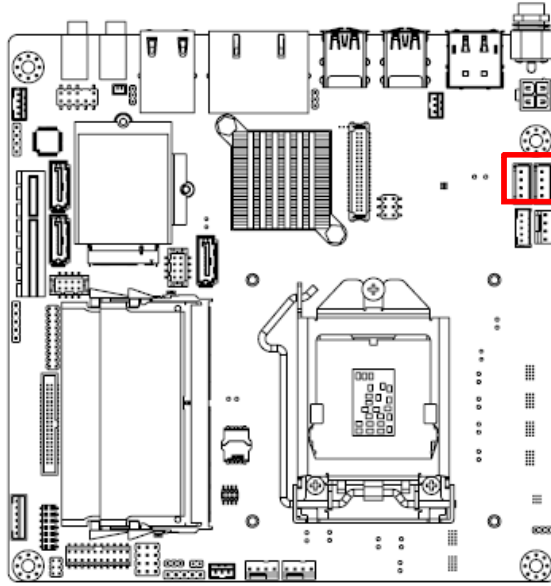

## 2.28 DC Input Connector (DCIN1)

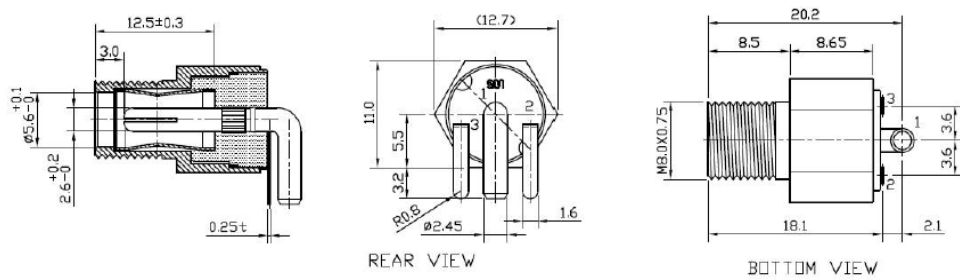
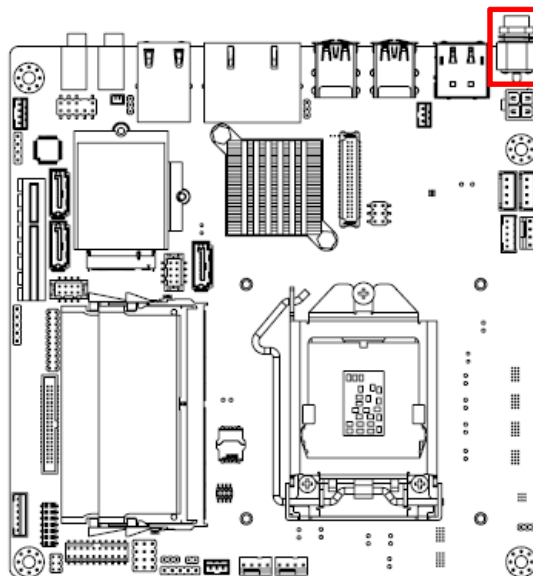

# Chapter 3

BIOS Operation

## 3.1 Introduction

With the AMI BIOS Setup program, you can modify BIOS settings and control the special features of your computer. The Setup program uses a number of menus for making changes and turning special features on or off. This chapter describes the basic navigation of the AIMB-286 setup screens.

## 3.2 BIOS Setup

The AIMB-286 Series system has AMI BIOS built in, with a CMOS SETUP utility that allows users to configure required settings or to activate certain system features. The CMOS SETUP saves the configuration in the CMOS RAM of the motherboard. When the power is turned off, the battery on the board supplies the necessary power to preserve the CMOS RAM.

When the power is turned on, press the <Del> button during the BIOS POST (Power-On Self Test) to access the CMOS SETUP screen.

<b>Control Keys</b>	
< ↑ >< ↓ >< ← >< → >	Move to select item
<Enter>	Select item
<Esc>	Main Menu - Quit without saving changes to the CMOS Sub Menu - Exit current page and return to the Main Menu
<Page Up/+>	Increase the numeric value or make changes
<Page Down/->	Decrease the numeric value or make changes
<F1>	General help, for Setup Sub Menu
<F2>	Item help
<F5>	Load previous values
<F7>	Load setup defaults
<F10>	Save all CMOS changes



### 3.2.1 Main Menu

Press <Del> to enter AMI BIOS CMOS Setup Utility, the Main Menu will appear on the screen. Use arrow keys to select among the items and press <Enter> to accept or enter the sub-menu.



The Main BIOS setup screen has two main frames. The left frame displays all the options that can be configured. Grayed-out options cannot be configured; options in blue can. The right frame displays the key legend.

Above the key legend is an area reserved for a text message. When an option is selected in the left frame, it is highlighted in white. Often a text message will accompany it.

#### ■ System Time/System Date

Use this option to change the system time and date. Highlight the System Time or System Date using the <Arrow> keys. Enter new values via the keyboard. Press the <Tab> or <Arrow> keys to move between fields. The date must be entered in MM/DD/YY format. The time must be entered in HH:MM:SS format.

### 3.2.2 Advanced BIOS Features

Select the Advanced tab from the AIMB-286 Setup menu to enter the Advanced BIOS Setup page. Users can select any item in the left frame of the screen, such as CPU Configuration, to access the submenu for that item. Select an Advanced BIOS Setup option by highlighting the text using the <Arrow> keys. All Advanced BIOS Setup options are described in this section. The Advanced BIOS Setup menu screen is shown below. The submenus are described in the following pages.

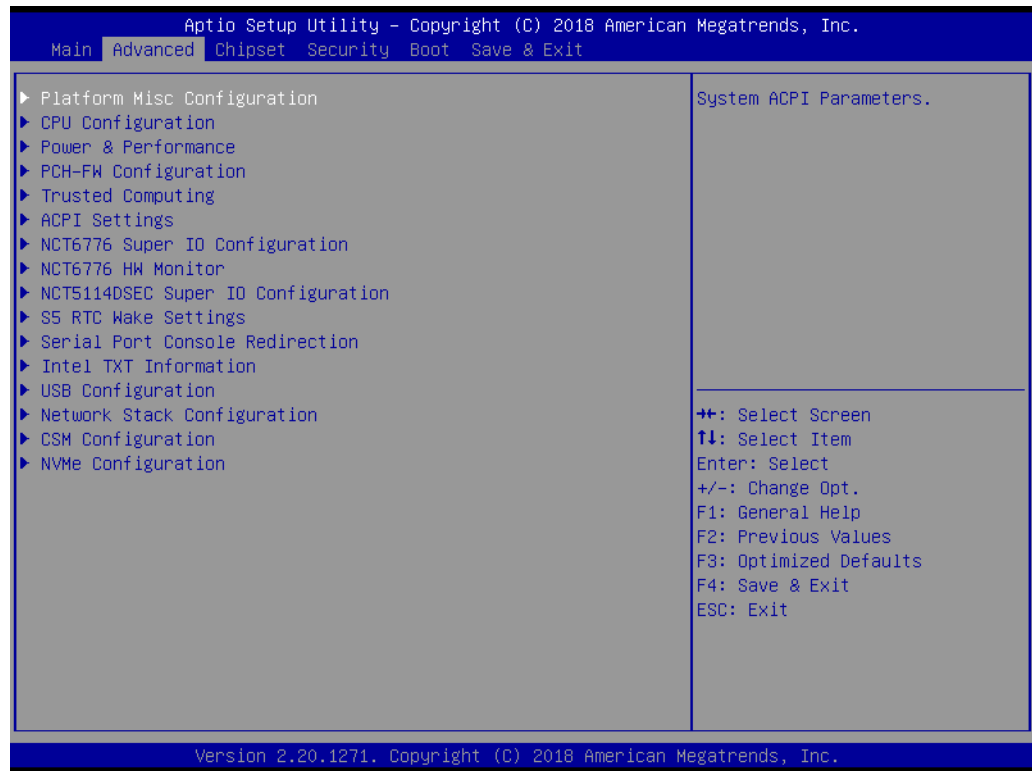

### 3.2.2.1 Platform Misc Configuration

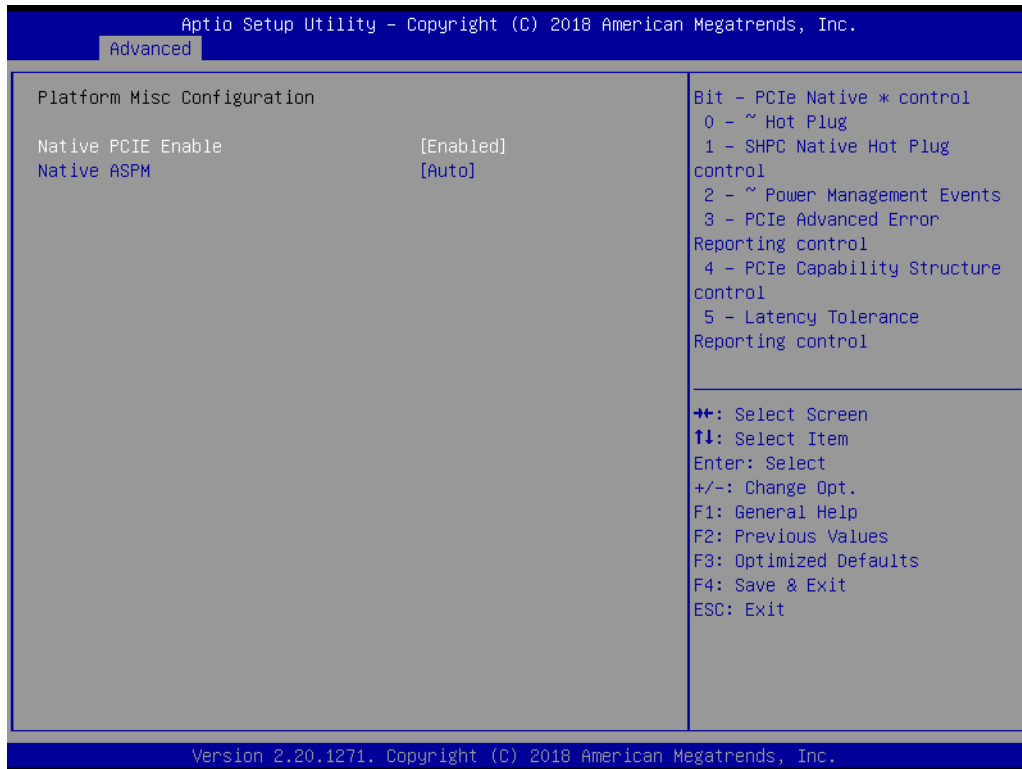

- Native PCIE Enable [ Enable ]
- Native ASPM [ Auto ]

### 3.2.2.2 CPU Configuration

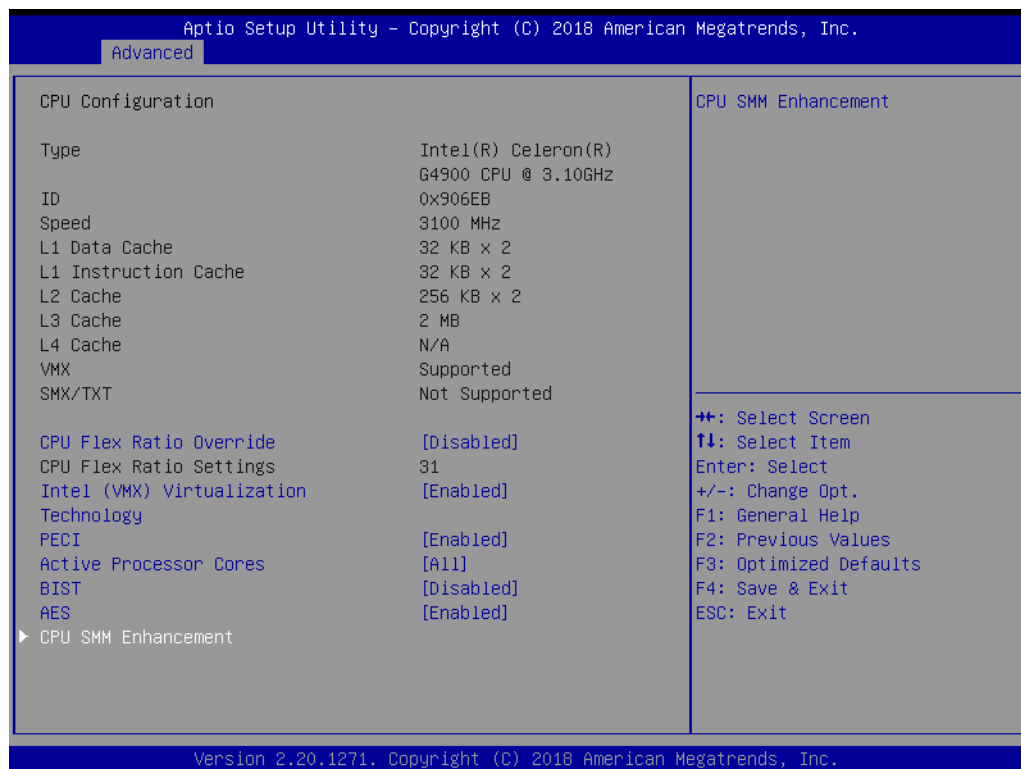
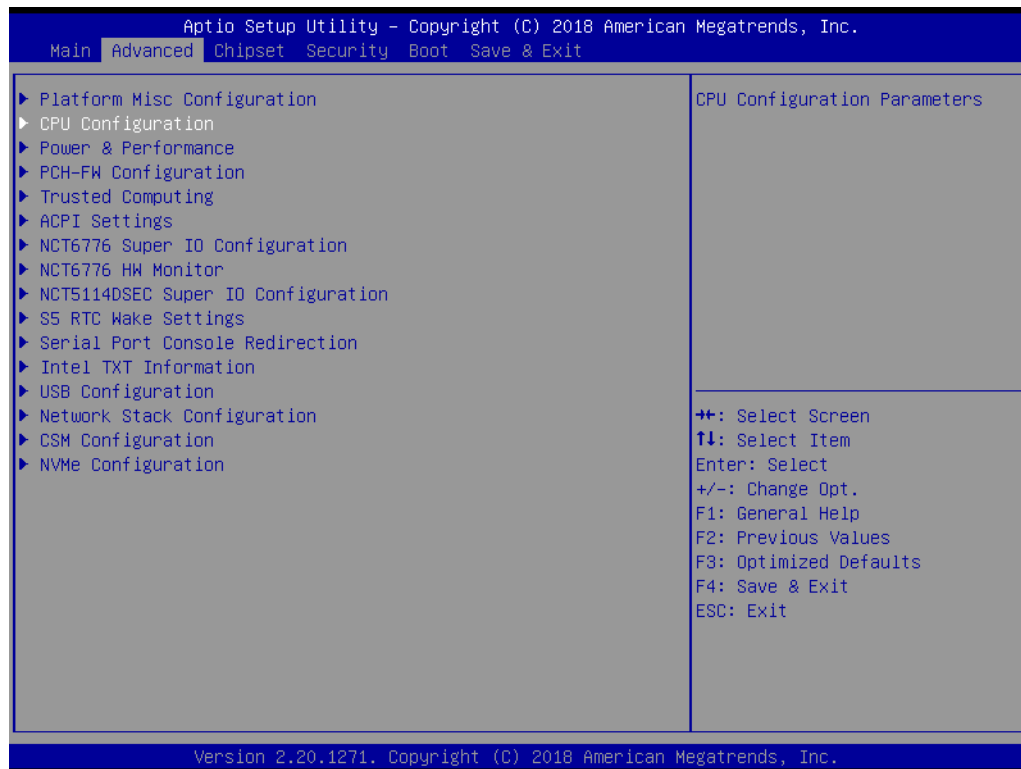

- CPU Flex Ratio Override [Disabled]
- Intel (VMX) Virtualization [Enabled]
- Peci [Enabled]
- Active Processor Cores [All]
- BIST [Disabled]
- AES [Enabled]

## CPU SMM Enhancement

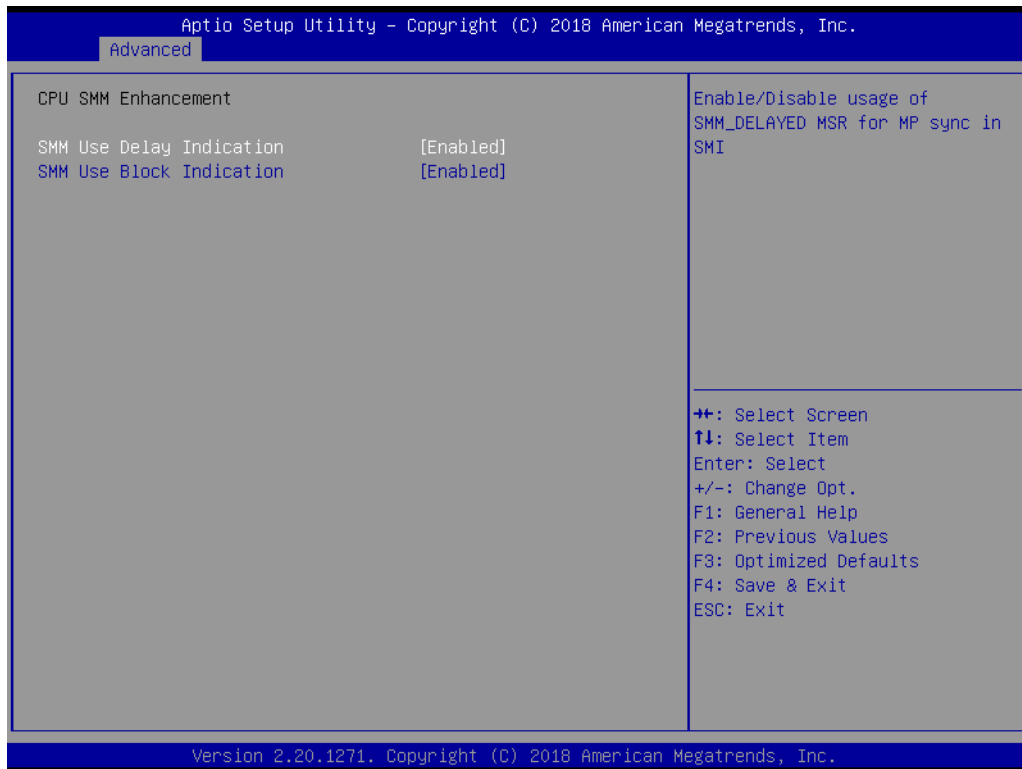

- SMM Use Delay Indication [Enabled]
- SMM Use Block Indication [Enabled]

### 3.2.2.3 Power & Performance

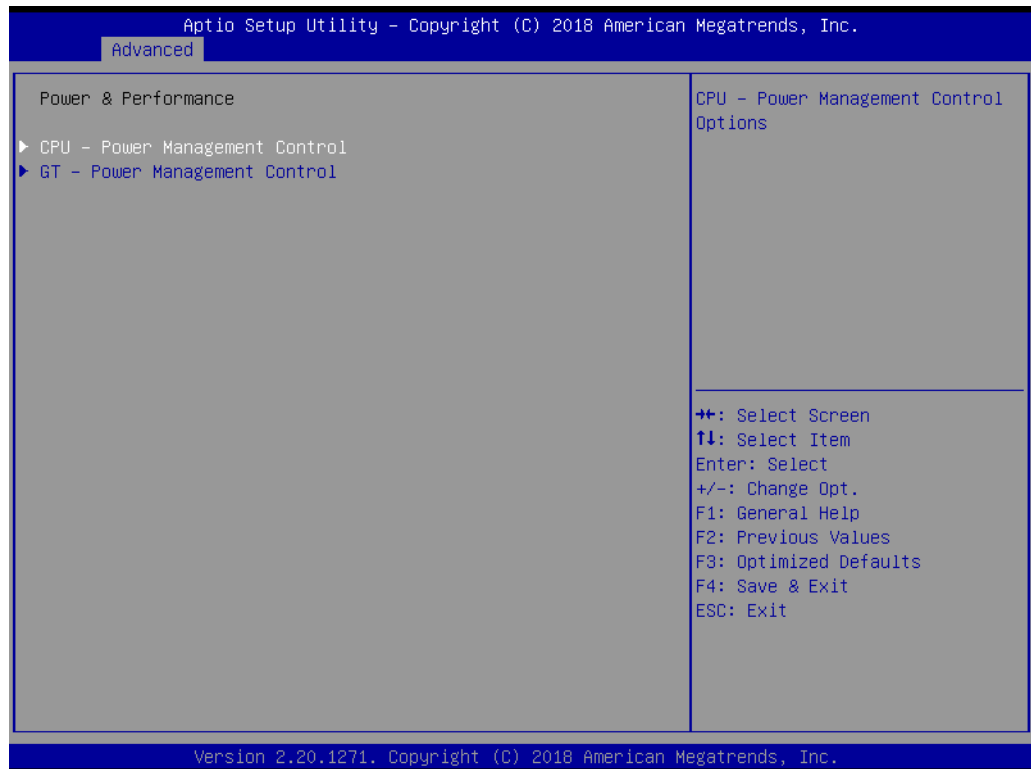
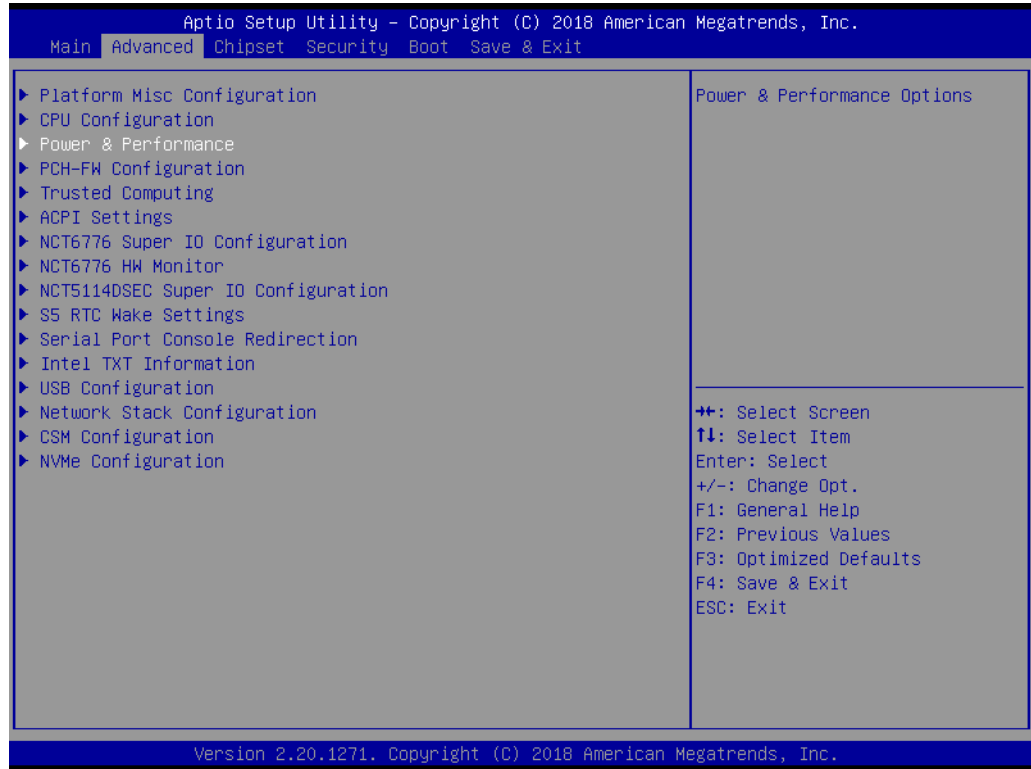

## CPU - Power Management Control

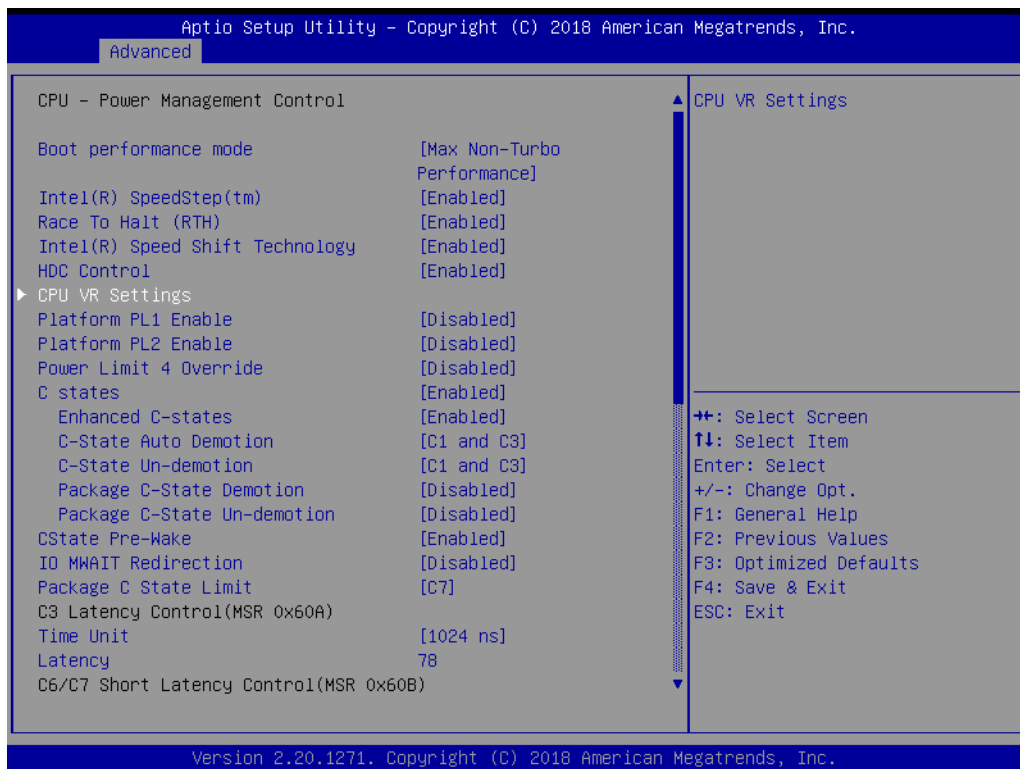

- Boot performance mode [Max Non-Turbo Performance]
- Intel® SpeedStep (tm) [Enabled]
- Race To Halt (RTH) [Enabled]
- Intel (R) Speed Shift Technology [Enabled]
- HDC Control [Enabled]
- Platform PL1 Enable [Disabled]
- Platform PL2 Enable [Disabled]
- Power Limit 4 Override [Disabled]
- C states [Enabled]
- Enhanced C-states [Enabled]
- C-state Auto Demotion [C1 and C3]
- C-state Un- demotion [C1 and C3]
- Package C-state Un-demotion [Disabled]
- Package C-state Demotion [Disabled]
- CState Pre-Wake [Enabled]
- IO MWAIT Redirection [Disabled]
- Package C-state Limit [C7]
- Time Unit [1024 ns]

## CPU VR Settings

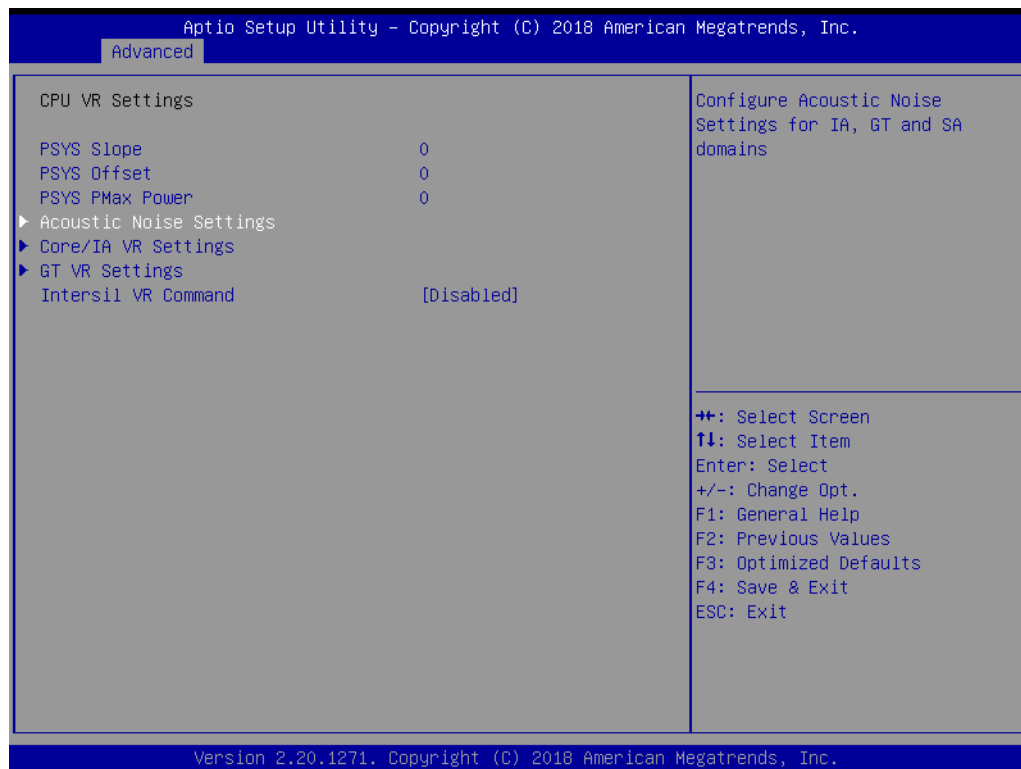

- Intersil VR Command [Disabled]

## Acoustic Noise Settings

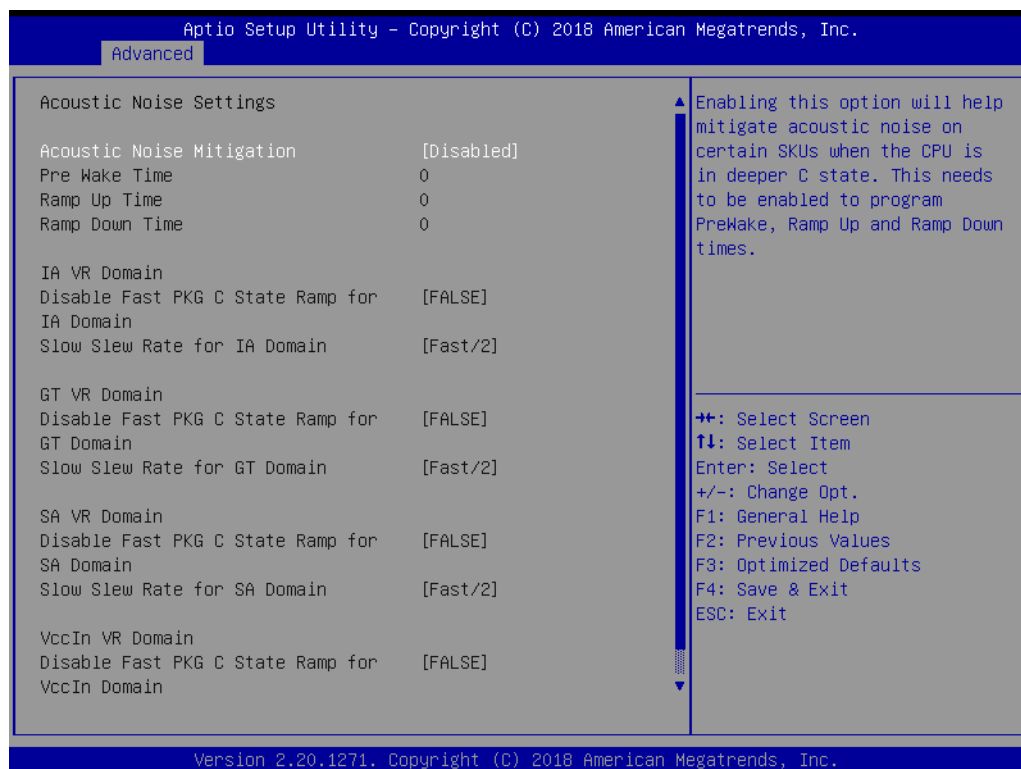

- Acoustic Noise Mitigation [Disabled]



- Disable Fast PKG C State Ramp for IA Domain [FALSE]
- Slow Slew Rate for IA Domain [Fast/2]
- Disable Fast PKG C State Ramp for GT Domain [FALSE]
- Slow Slew Rate for GT Domain [Fast/2]
- Disable Fast PKG C State Ramp for SA Domain [FALSE]
- Slow Slew Rate for SA Domain [Fast/2]
- Disable Fast PKG C State Ramp for VccIn Domain [FALSE]

### Core/IA VR Settings



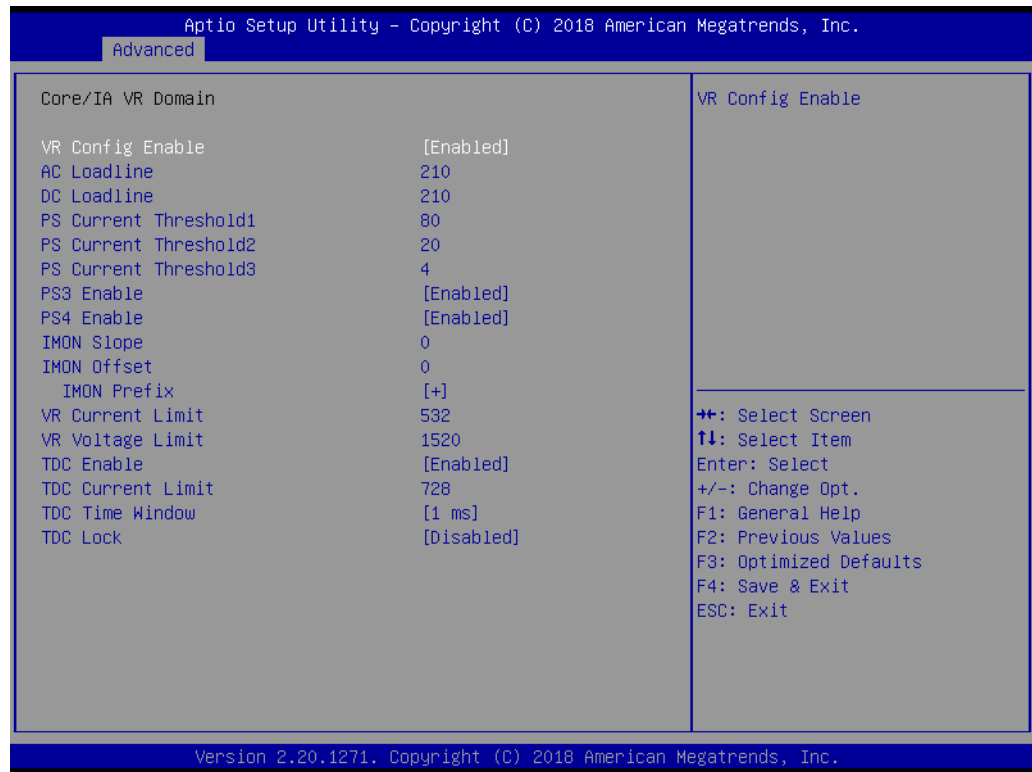

- VR Config Enable [ Enabled ]
- PS3 Enable [Enabled]
- PS4 Enable [Enabled]
- TDC Enable [Enabled]
- TDC Time Window [1 ms]
- TDC Lock [Disabled]

## CPU VR Settings

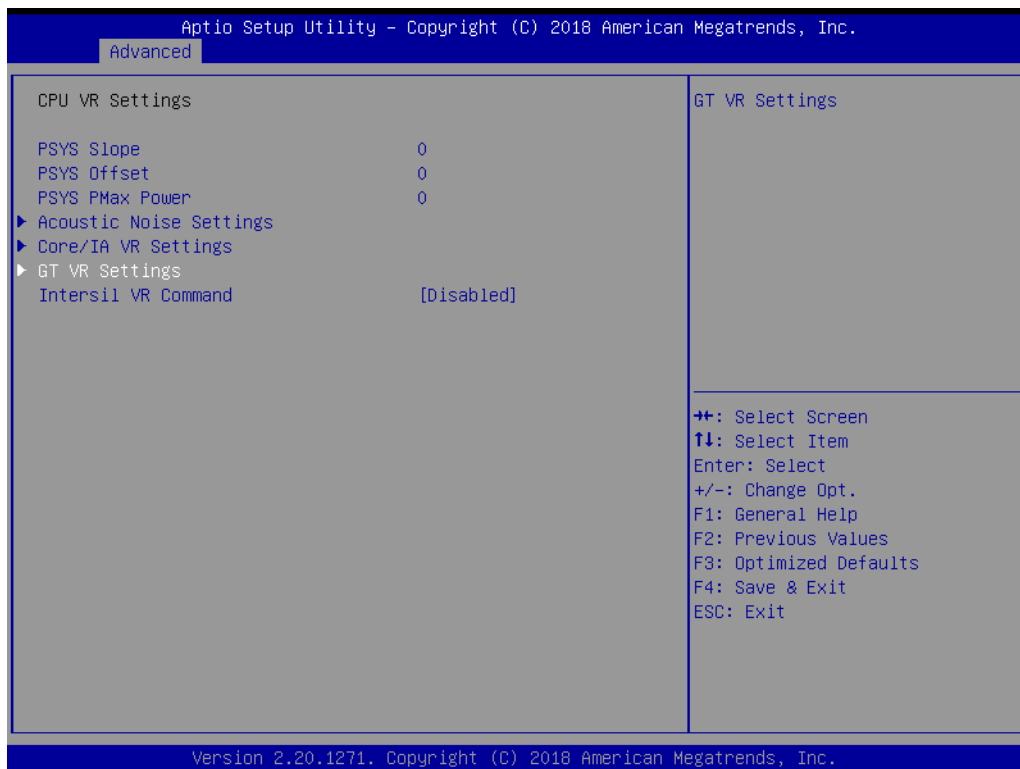

- VR Config Enable [ Enabled ]
- PS3 Enable [Enabled]
- PS4 Enable [Enabled]
- TDC Enable [Enabled]
- TDC Time Window [1 ms]

■ TDC Lock [Disabled]

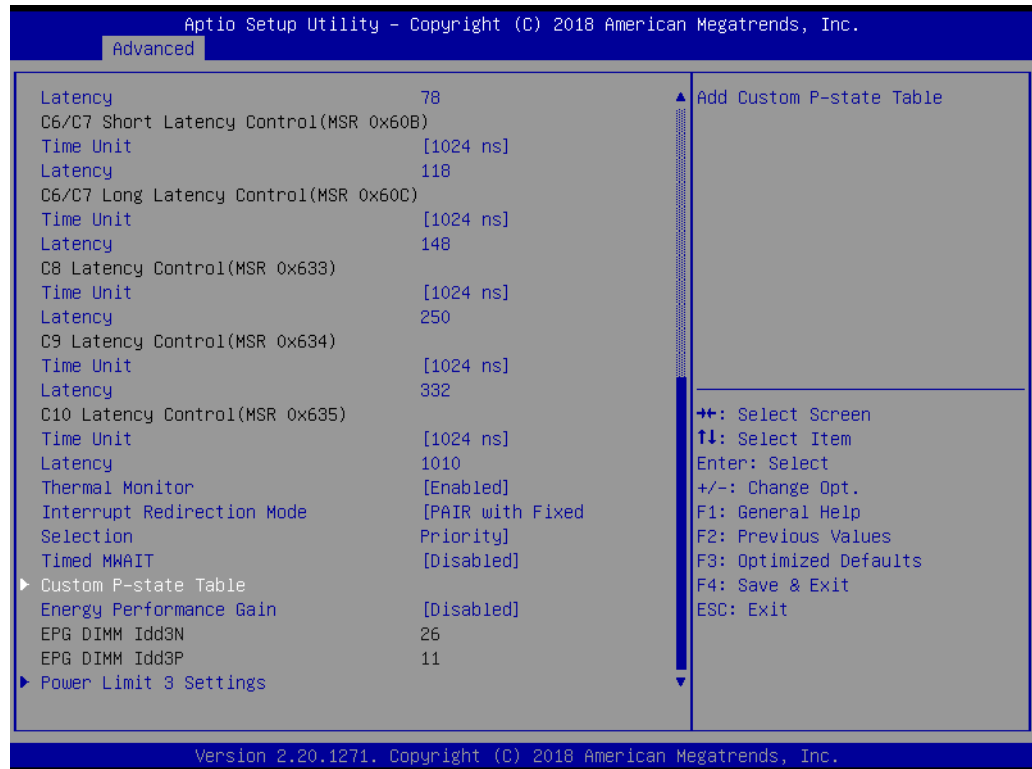

**Custom P-state Table**



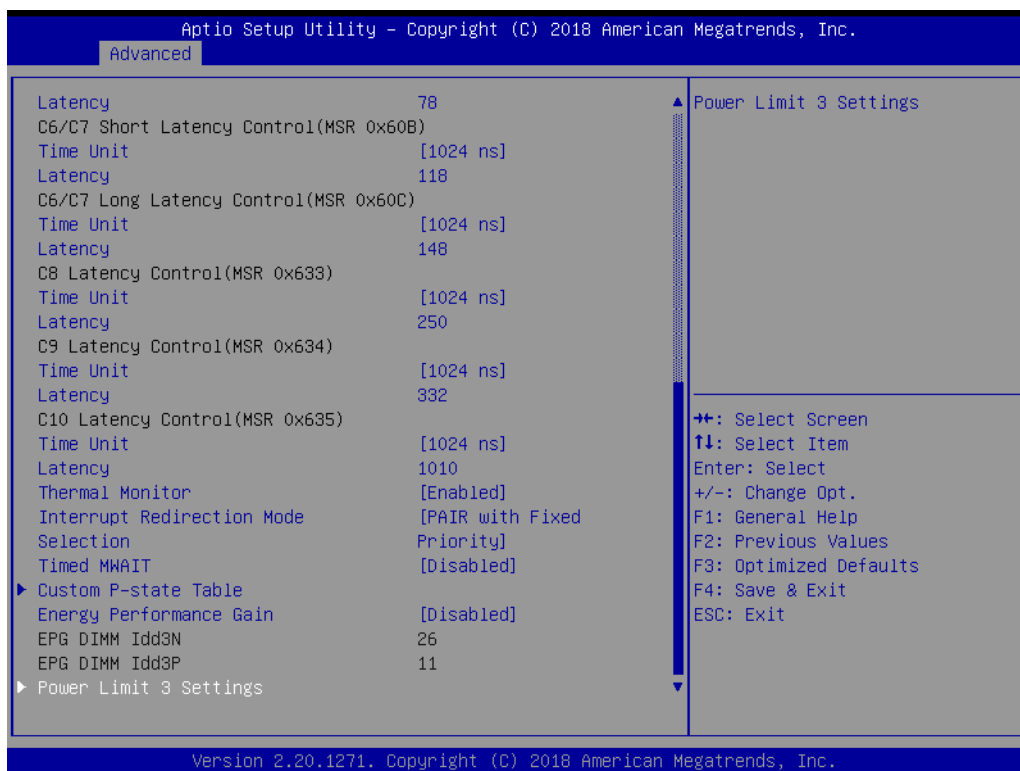

- Power Limit 3 Override [Disabled]

### 3.2.2.4 PCH-FW Configuration

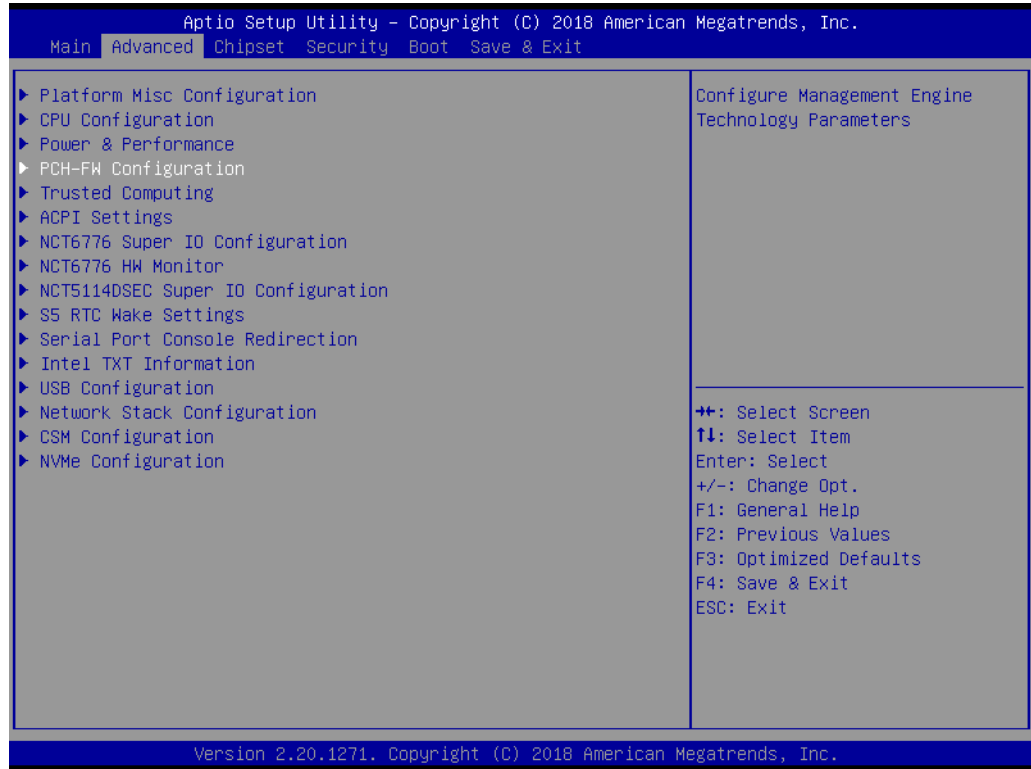

- Me FW Image Re-Flash [Disabled]
- Local FW Update [Enabled]

### 3.2.2.5 Power & Performance

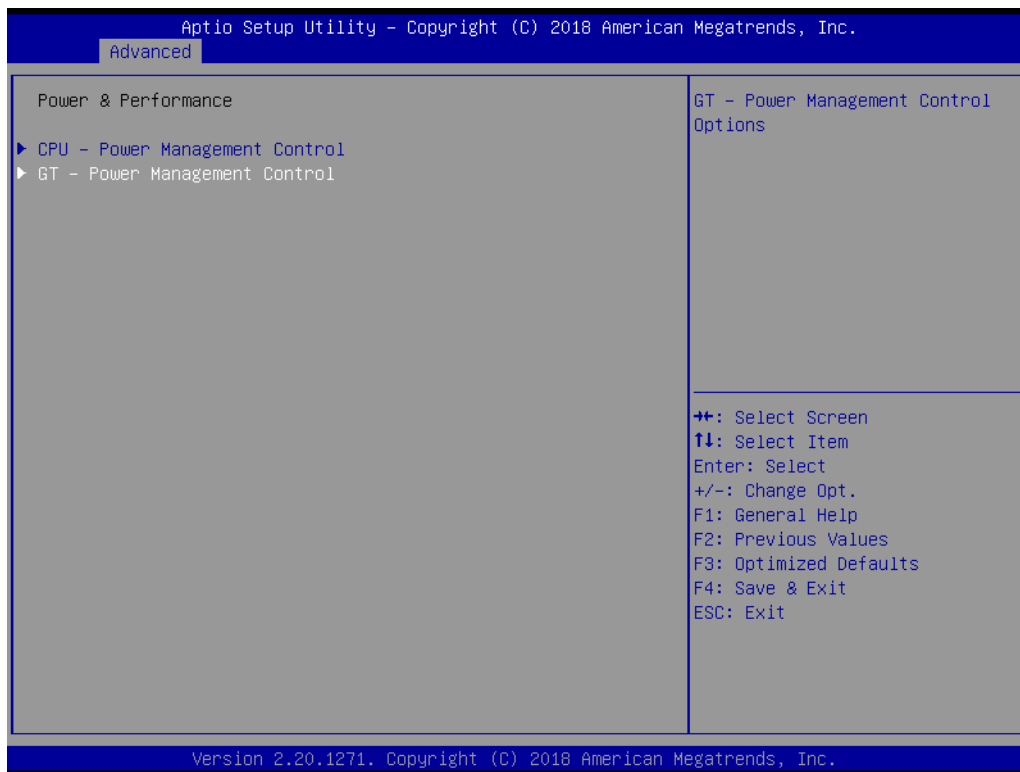

- RC6 (Render Standby) [Enabled]
- Maximum GT frequency [Default Max Frequency]
- Disable Turbo GT frequency [Disabled]

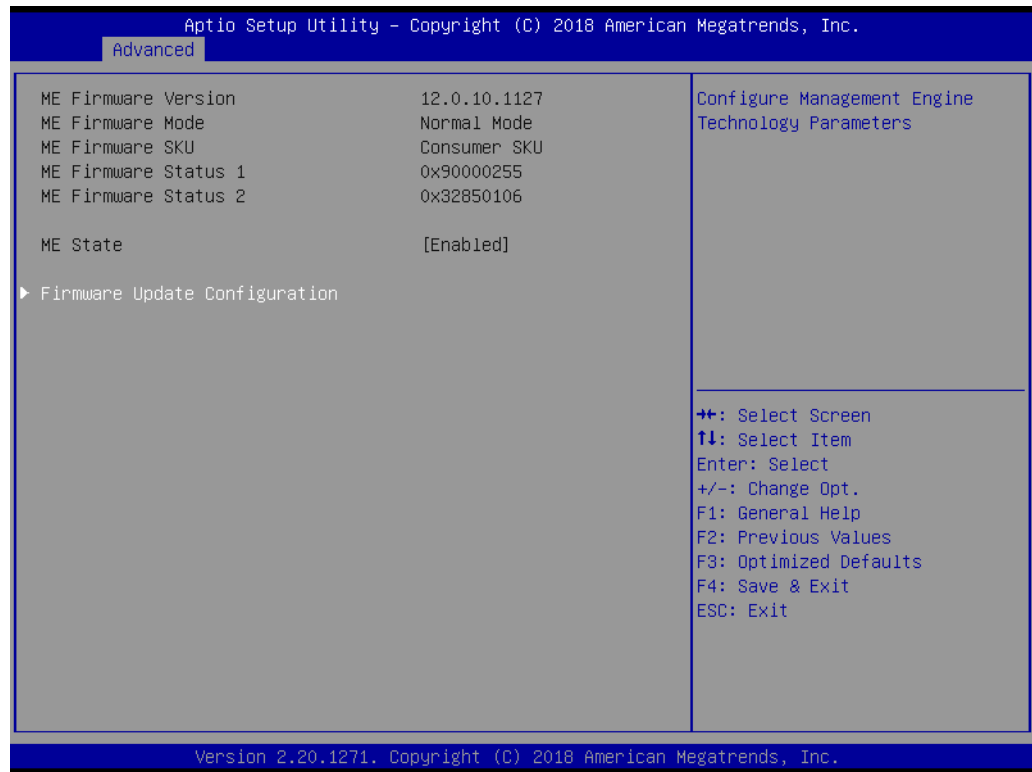

- ME State [Enabled]

### 3.2.2.6 Trusted Computing

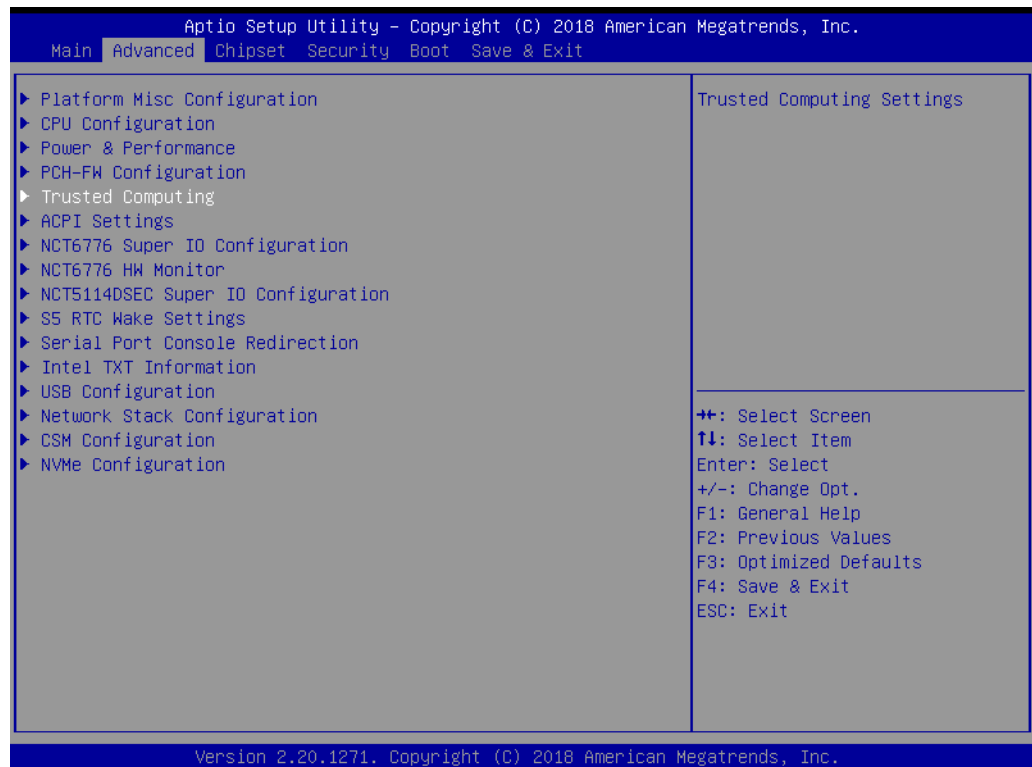



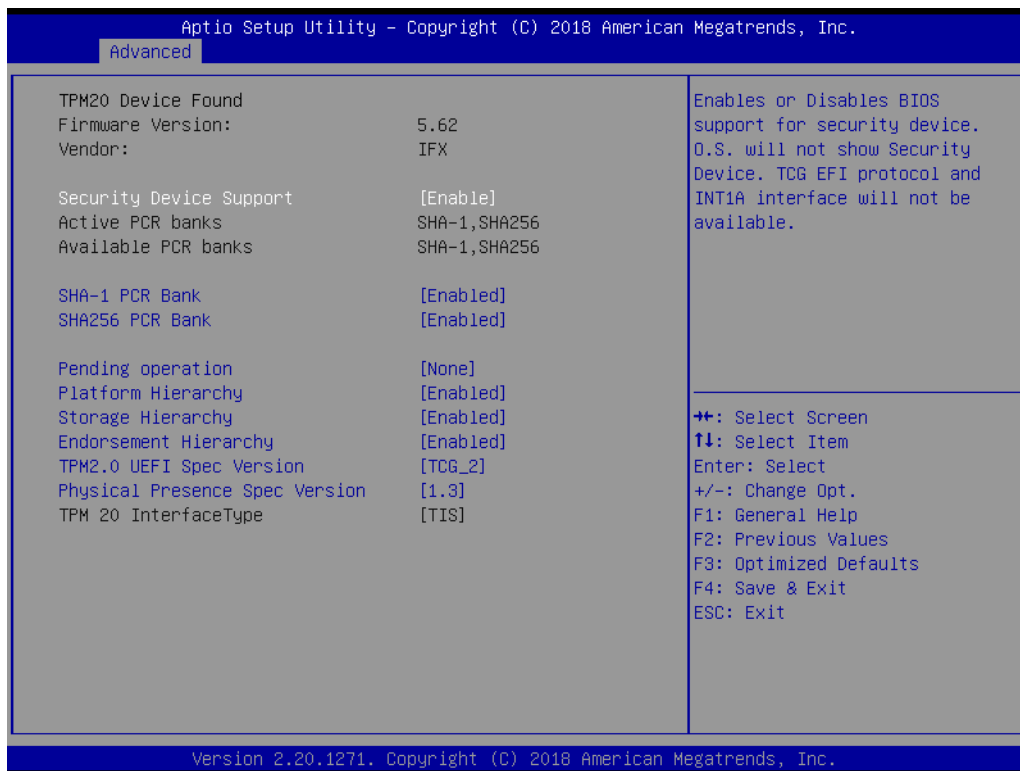

- Security Device Support [Enabled]
- SHA-1 PCR Bank [Enabled]
- SHA256 PCR Bank [Enabled]
- Pending operation [None]
- Platform Hierarchy [Enabled]
- Storage Hierarchy [Enabled]
- Endorsement Hierarchy [Enabled]
- TPM2.0 UEFI Spec Version [TCG\_2]
- Physical Presence Spec Version [1.3]
- TPM 20 Interface Type [TIS]

### 3.2.2.7 ACPI Settings

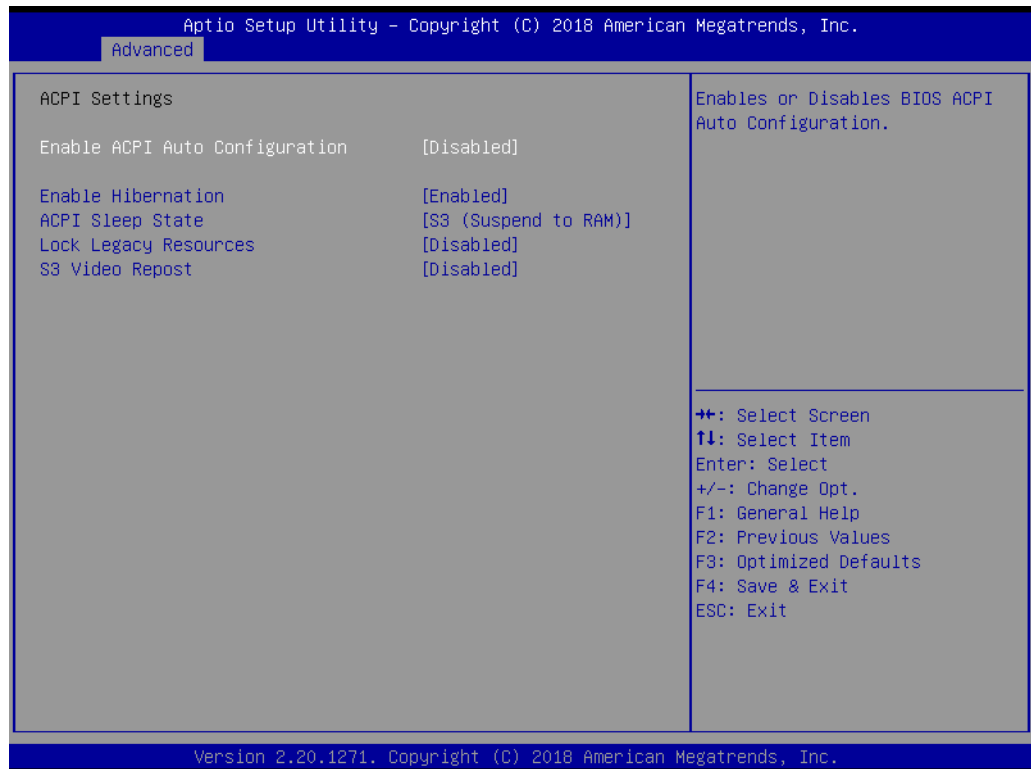
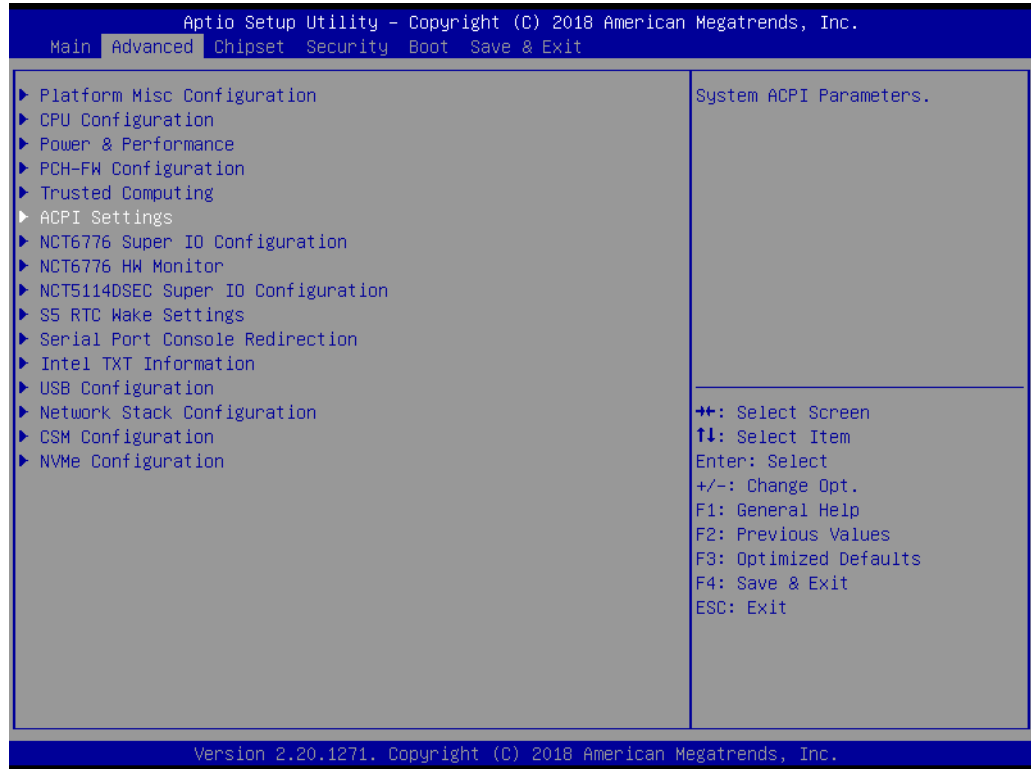

- Enable ACPI Auto Configuration [ Disabled ]
- Enable Hibernation [Enabled]
- ACPI Sleep State [S3 (Suspend to RAM)]
- Lock Legacy Resource [Disabled]
- S3 Video Repost [Disabled]

### 3.2.2.8 NCT6776 Super IO Configuration

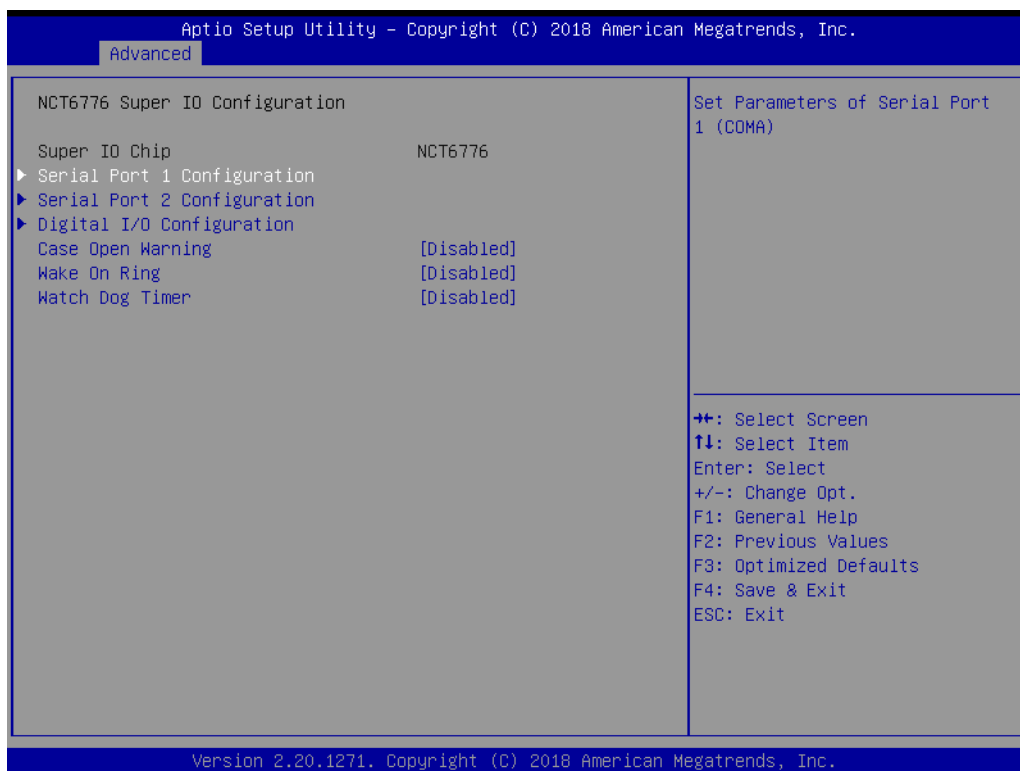
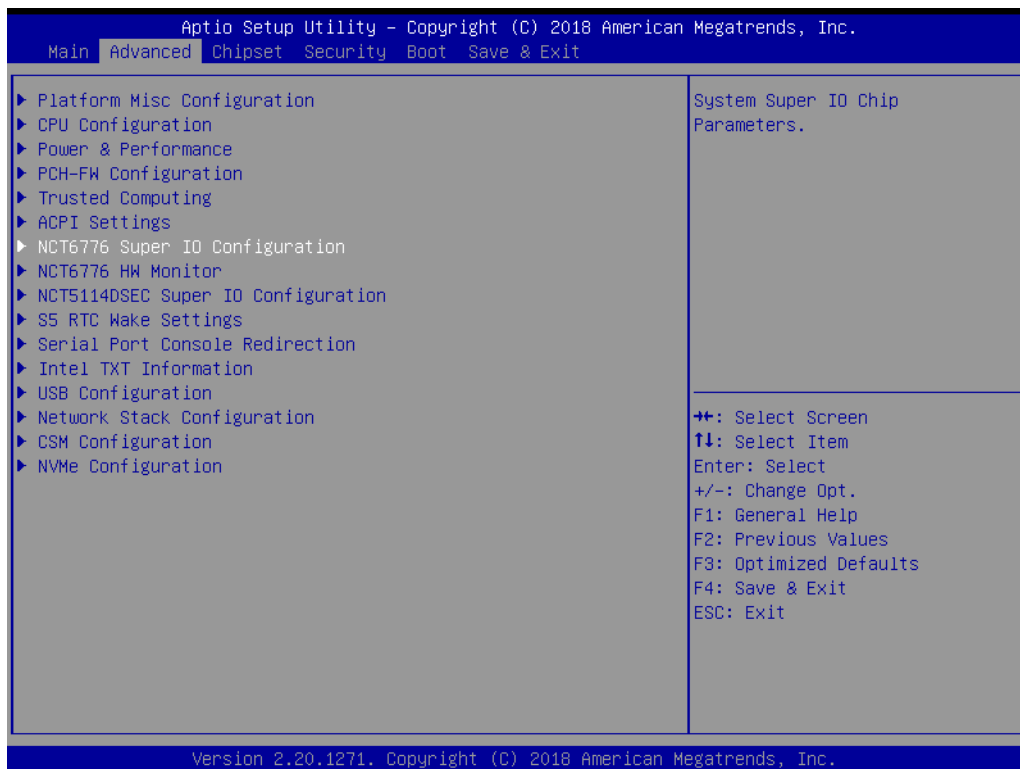

#### Super IO Chip NCT6776

- Case Open Warning [Disabled]
- Wake On Ring [Disabled]
- Watch Dog Timer [Disabled]

## Serial Port 1 Configuration

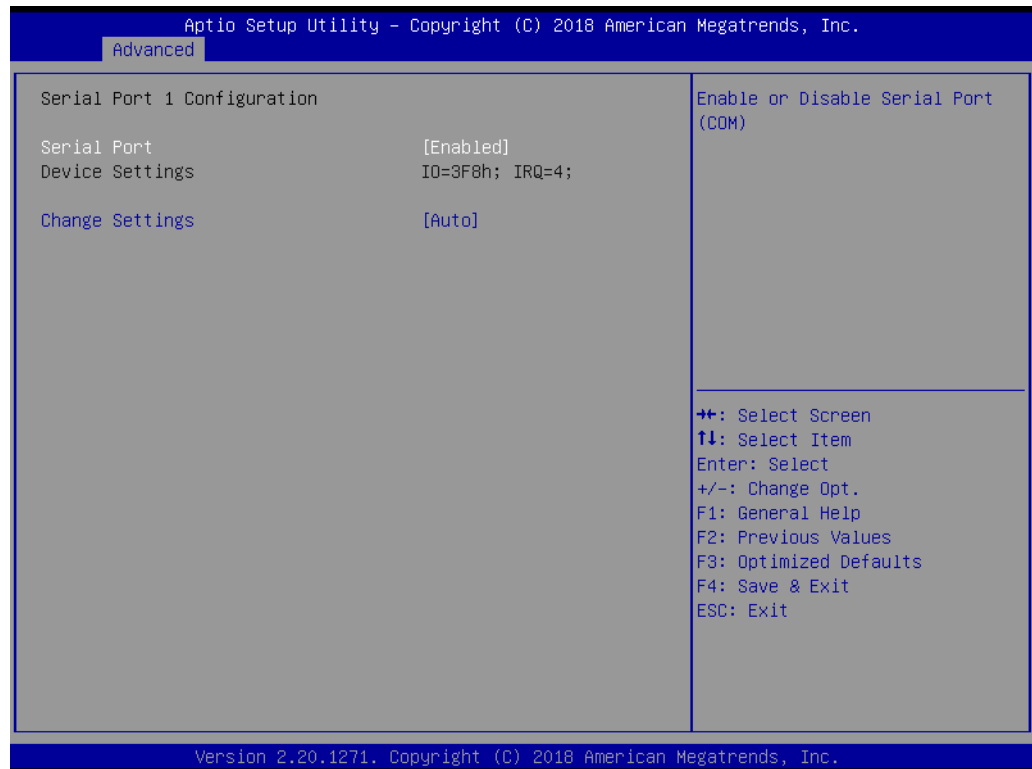

- Serial Port [ Enabled ]
  - Device Settings: IO=3F8h; IRQ =4
  - Change Settings [ Auto ]To select an optimal setting for serial port 1.

## Serial Port 2 Configuration



- Serial Port [ Enabled ]
- Device Settings: IO=2F8h; IRQ =3
- Change Settings [ Auto ]  
To select an optimal setting for serial port 2.
- RS485 Auto Flow Control Function [ Disabled ]

### Digital I/O Configuration

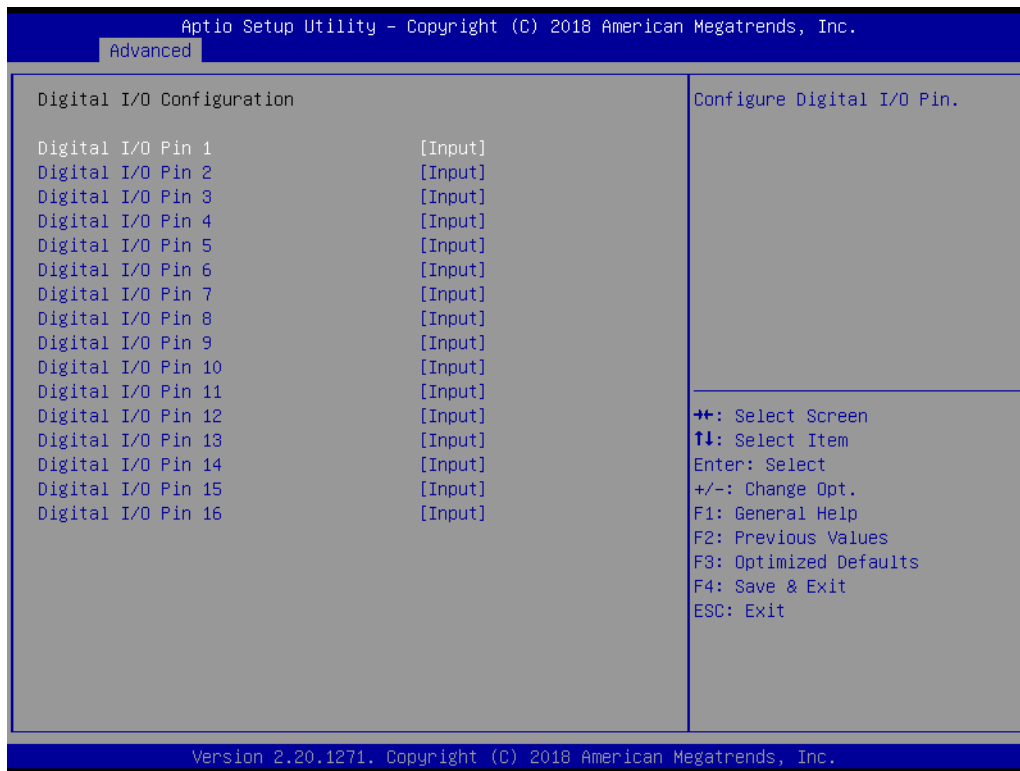

- Digital I/O Pin 1 - 16 [ Input ]

### 3.2.2.9 NCT6776 HW Monitor

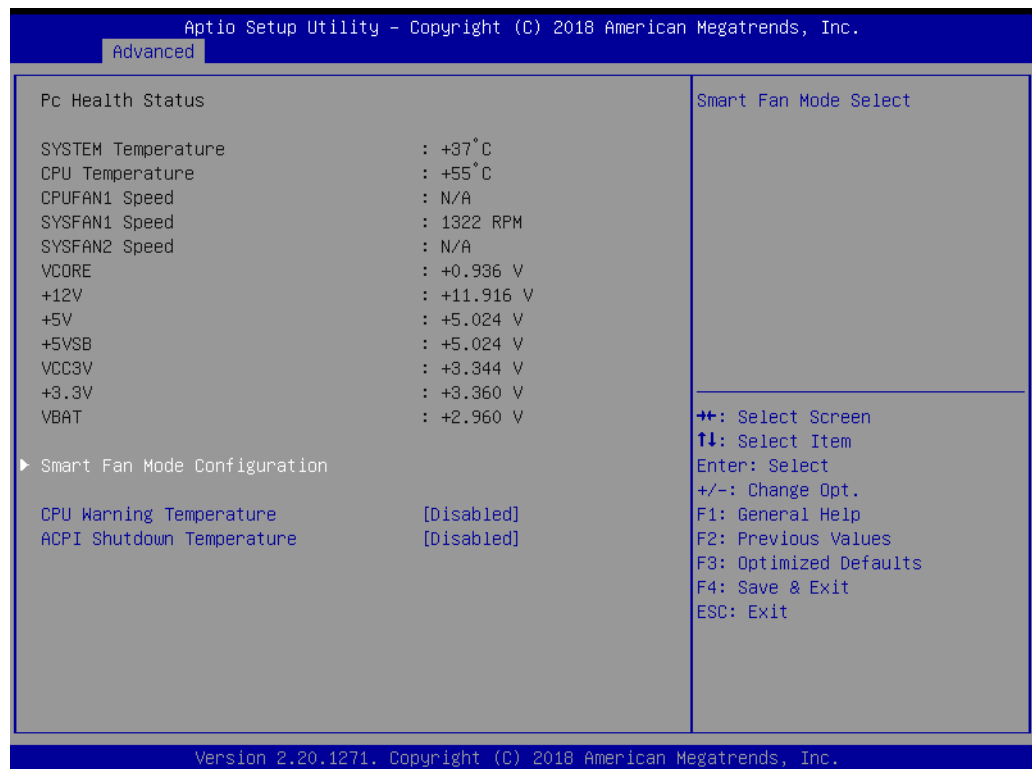
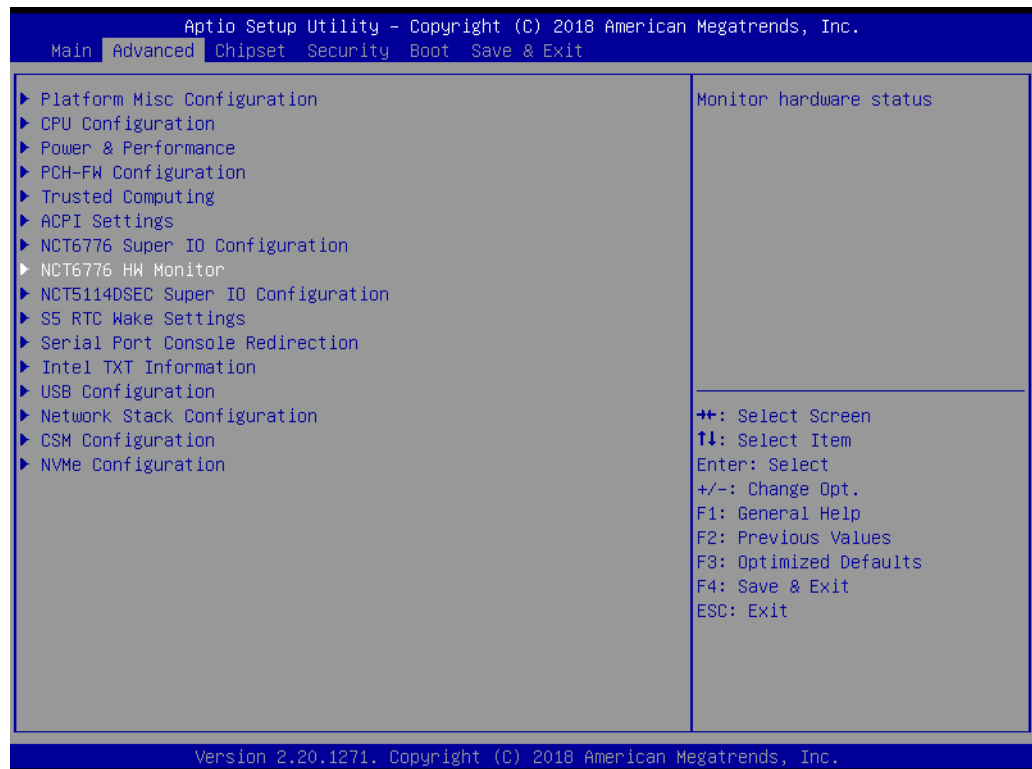

- **CPU Warning Temperature [ Disabled ]**  
Use this to set the CPU warning temperature threshold. When the system reaches the warning temperature, the speaker will beep.
- **ACPI Shutdown Temperature [ Disabled ]**  
Use this to set the ACPI shutdown temperature threshold. When the system reaches the shutdown temperature, it will be automatically shut down by ACPI OS to protect the system from overheating damage.

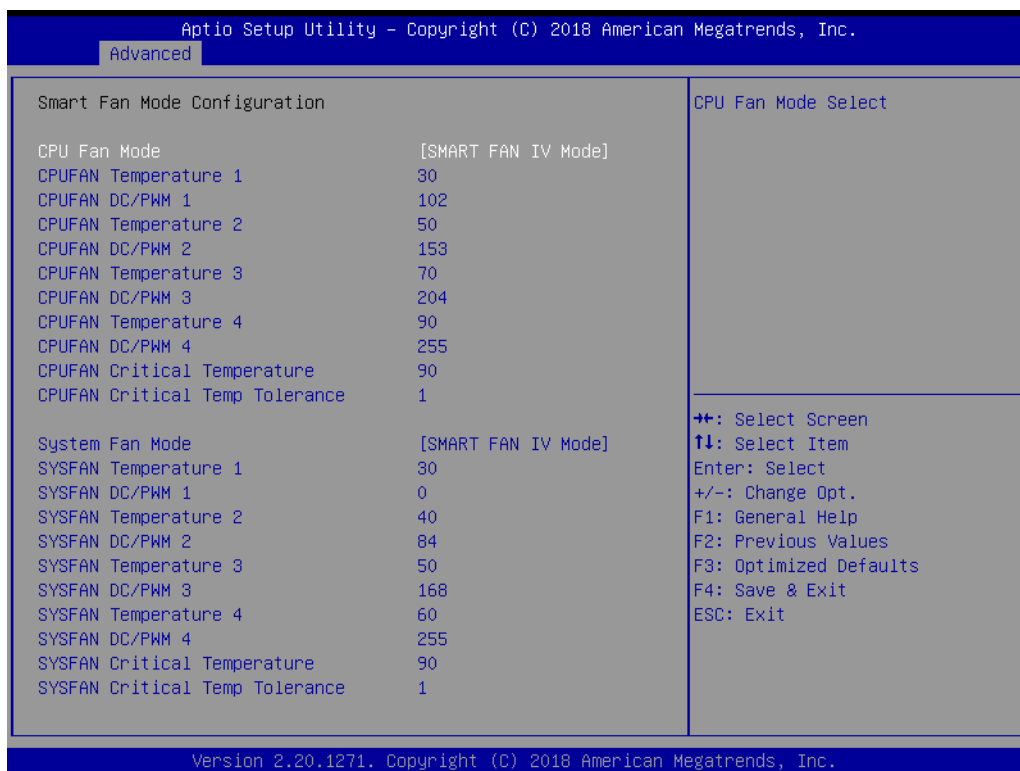

### Smart Fan Mode Configuration

- CPU FAN Mode [ SMART FAN IV Mode ]  
The item shows you CPU temperature and fan speed (PWM) information.
- SYSFAN Mode [ SMART FAN IV Mode ]  
The item shows you system temperature and fan speed (PWM) information.

### 3.2.2.10 NCT5114DSEC Super IO Configuration

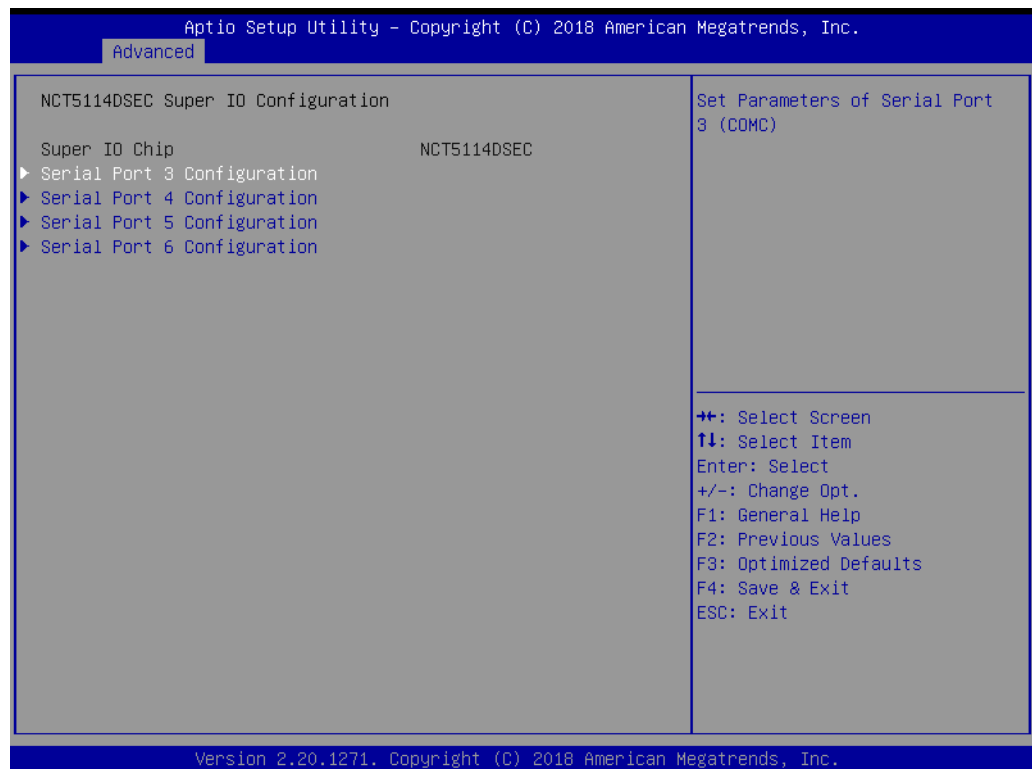
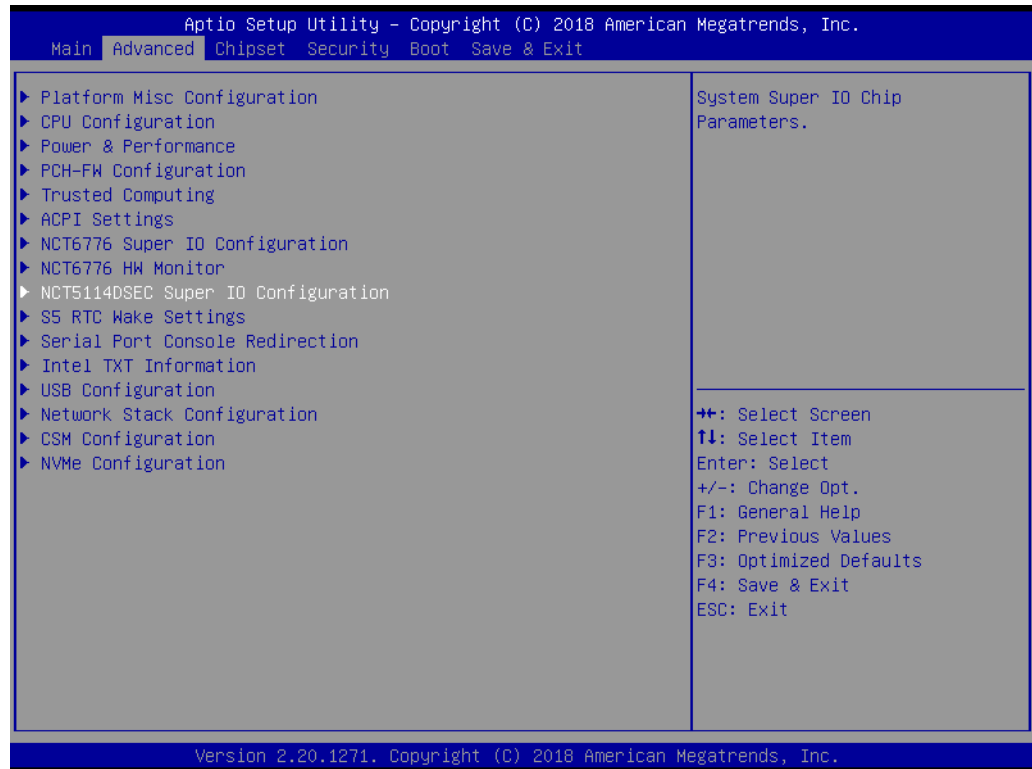



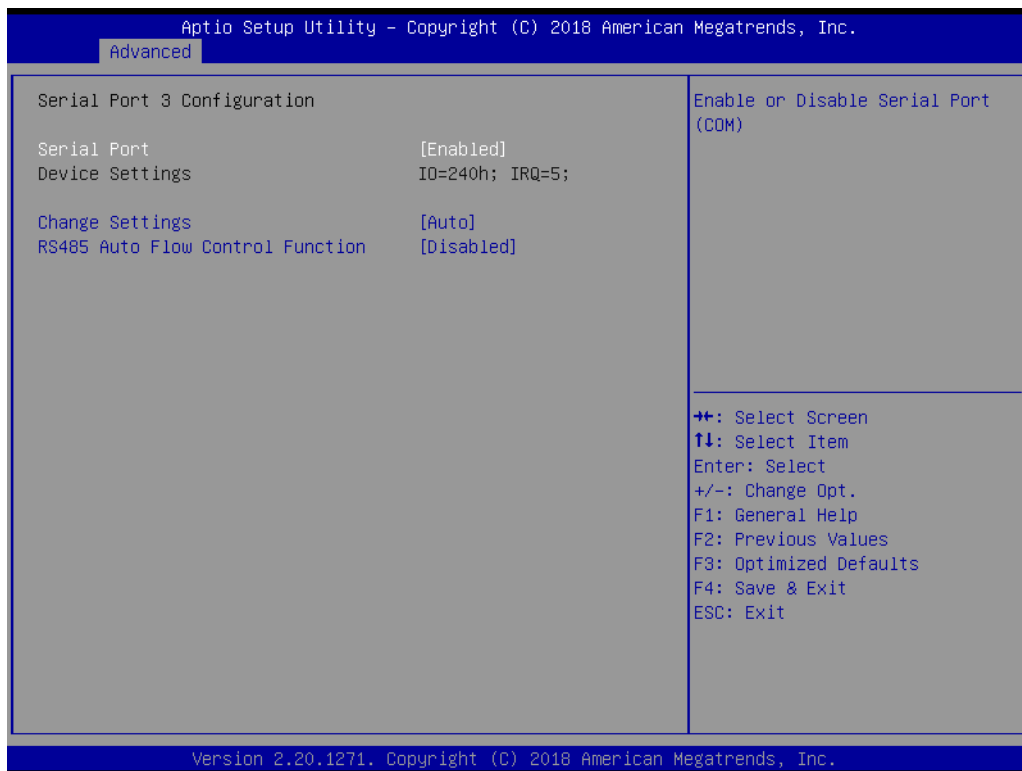

### Serial Port 3 Configuration

- Serial Port [ Enabled ]  
Device Settings: IO=240h; IRQ =5
- Change Setting [ Auto ]  
To select an optimal setting for serial port 3.
- RS-485 Auto Flow Control Function [ Disabled ]

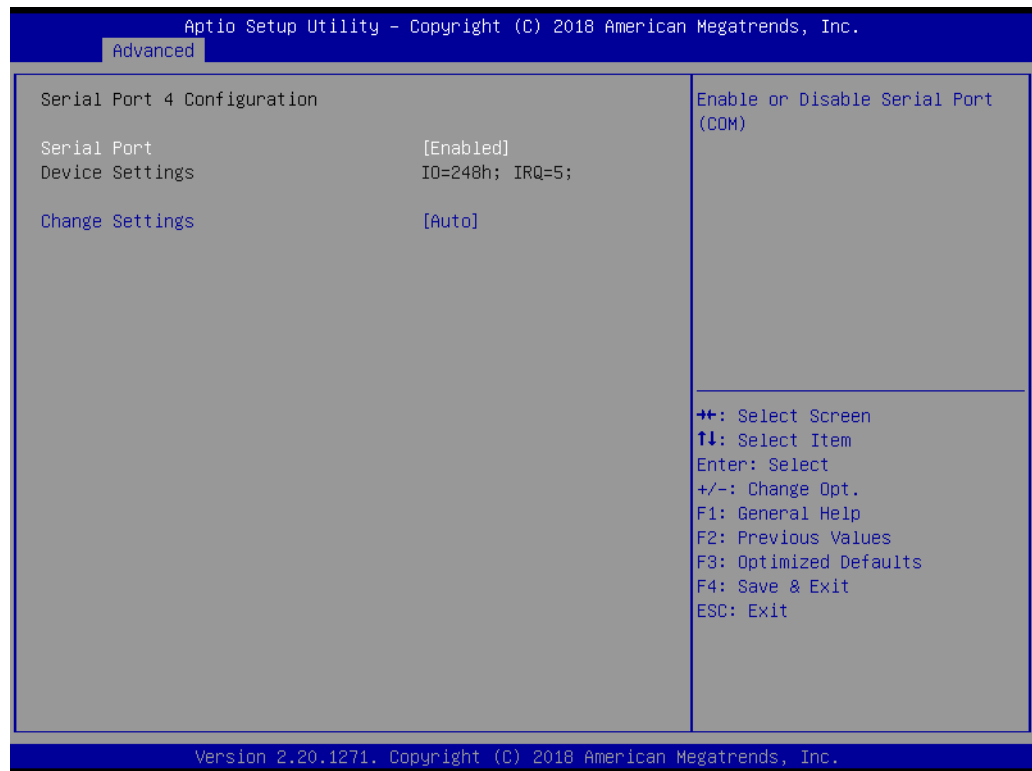

### Serial Port 4 Configuration

- Serial Port [ Enabled ]  
Device Settings: IO=248h; IRQ =5
- Change Setting [ Auto ]  
To select an optimal setting for serial port 4.

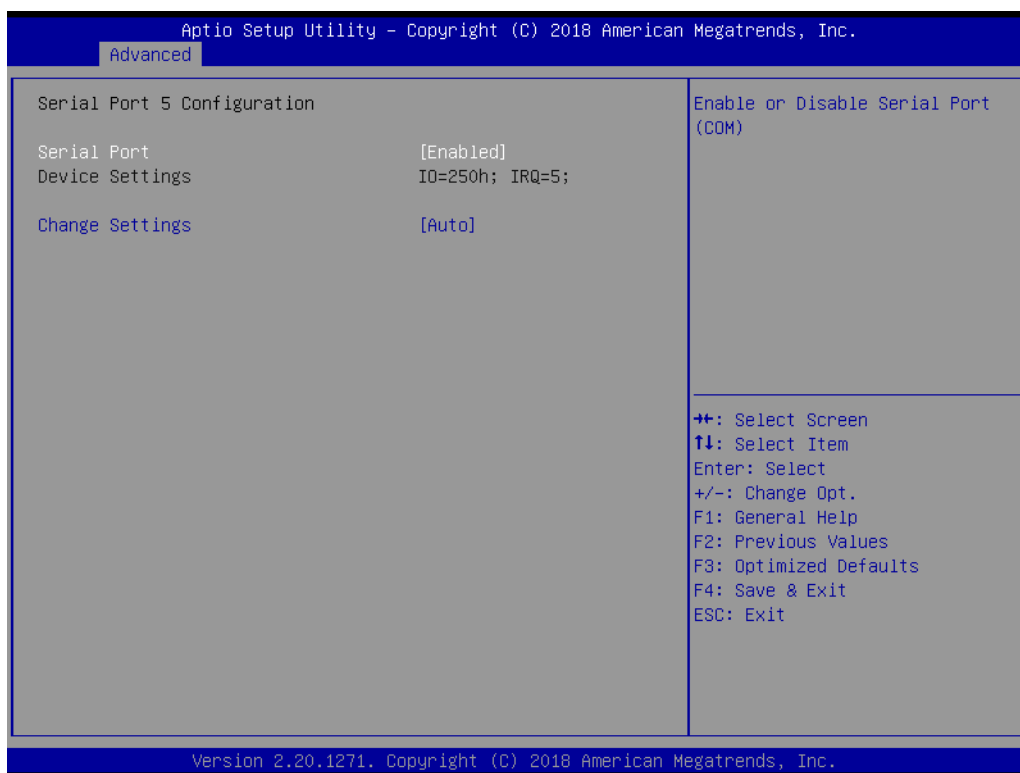

### Serial Port 5 Configuration

- Serial Port [ Enabled ]  
Device Settings: IO=250h; IRQ =5
- Change Setting [ Auto ]  
To select an optimal setting for serial port 5.

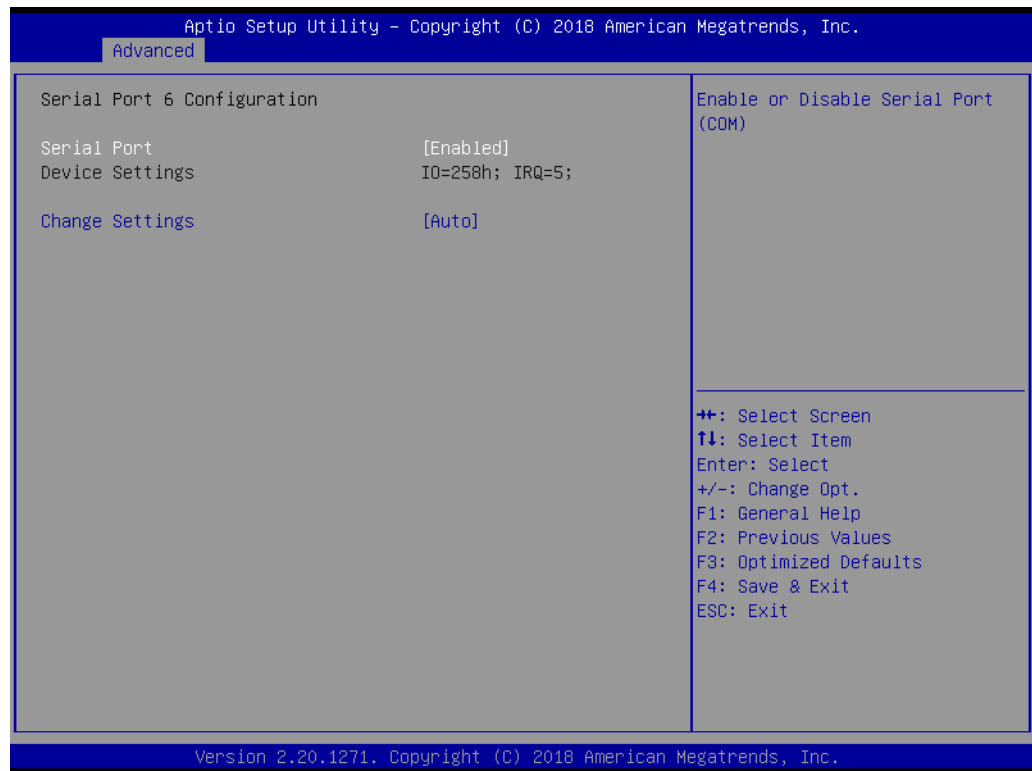

### Serial Port 6 Configuration

- Serial Port [ Enabled ]  
Device Settings: IO=258h; IRQ =5
- Change Setting [ Auto ]  
To select an optimal setting for serial port 6.

### 3.2.2.11 S5 RTC Wake Settings

The item allows you enable or disable system wake up on alarm event.

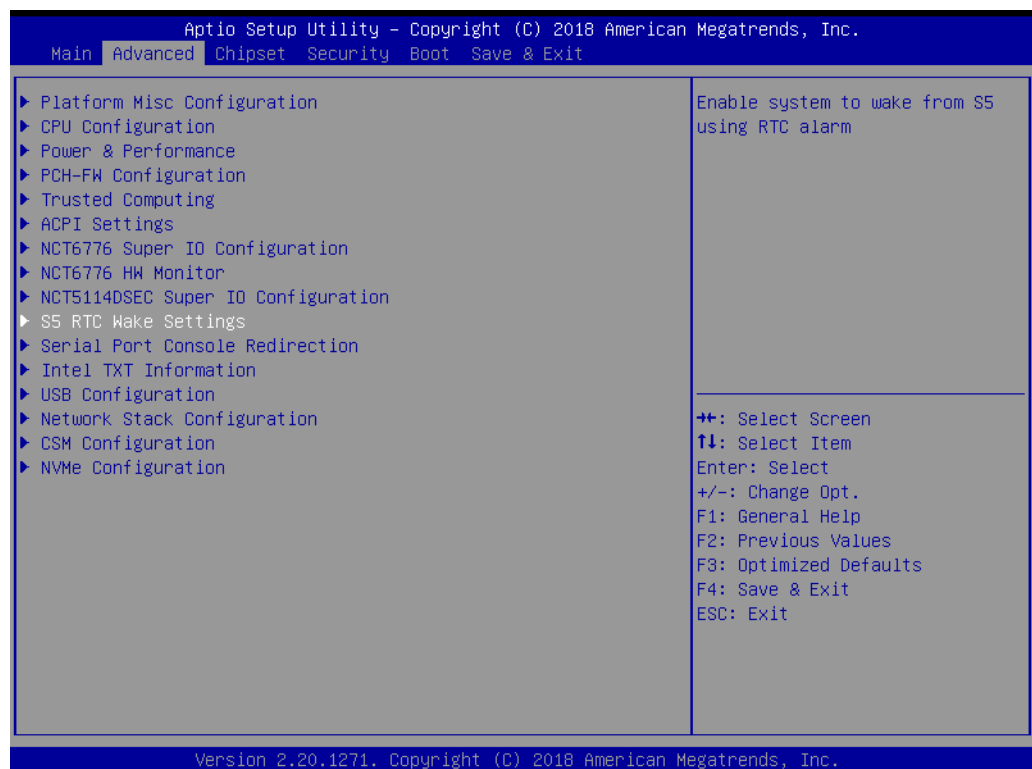

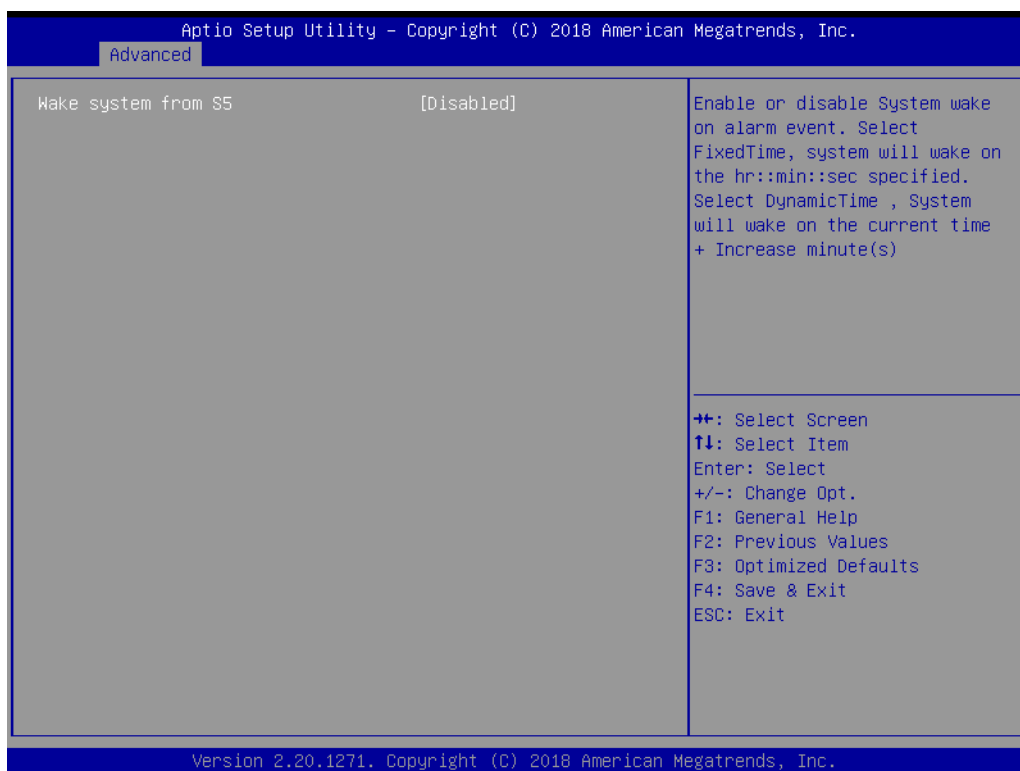

- Wake system from S5 [ Disabled ]

### 3.2.2.12 Serial Port Console Redirection

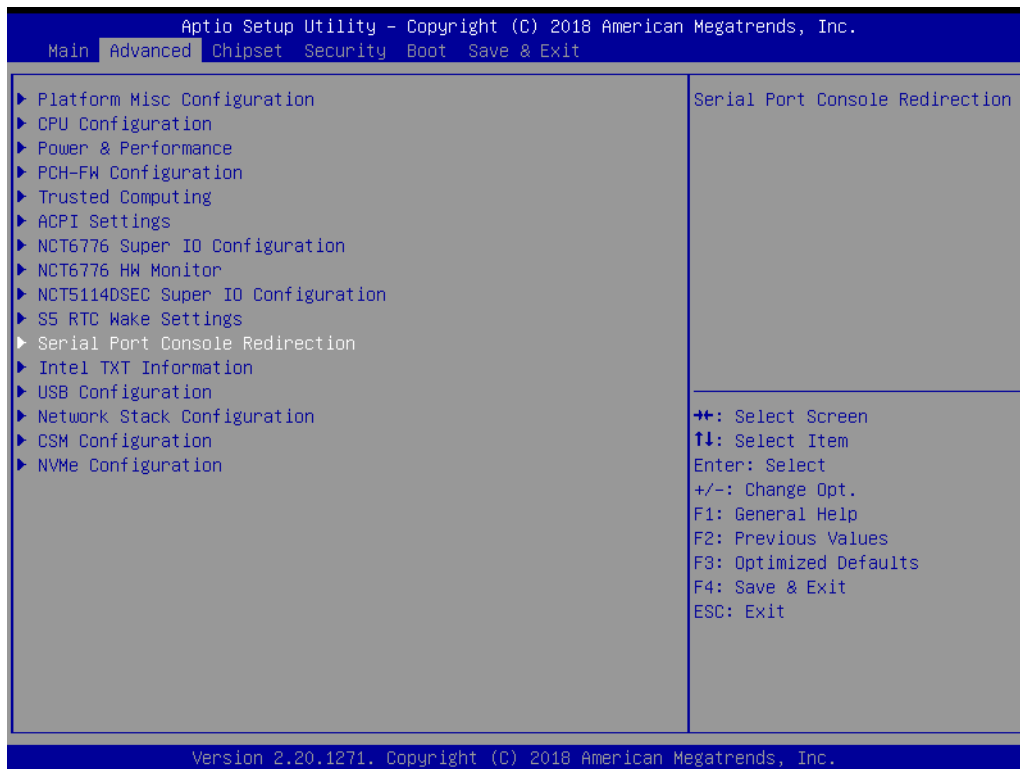

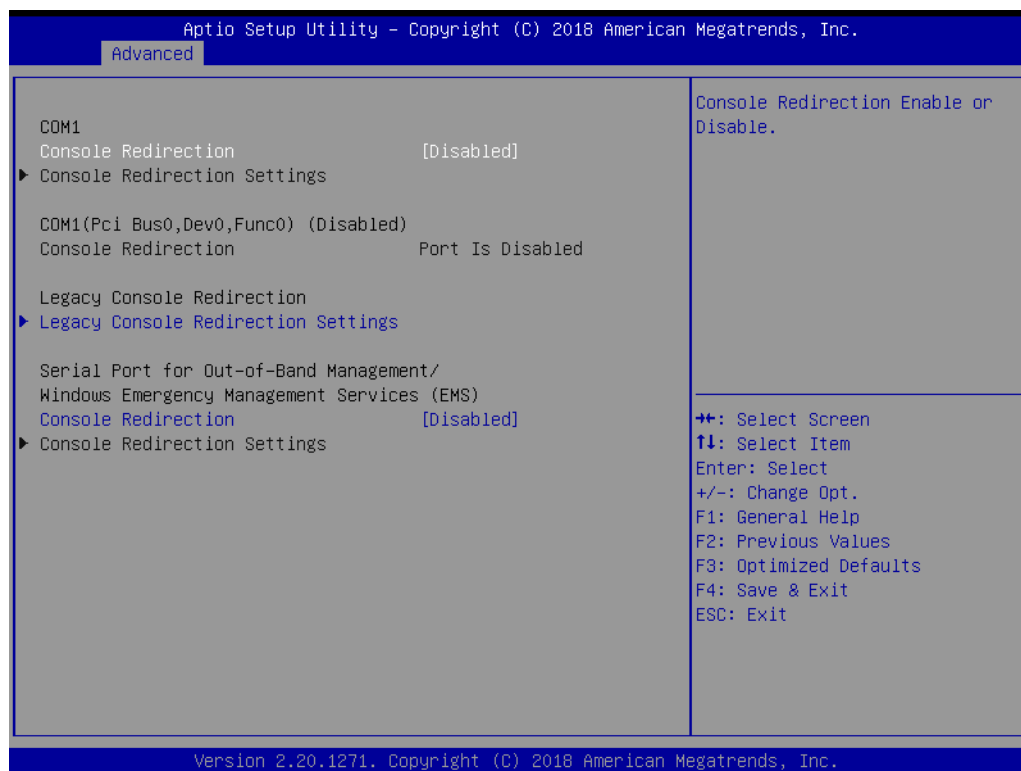

- Console Redirection [ Disabled ]

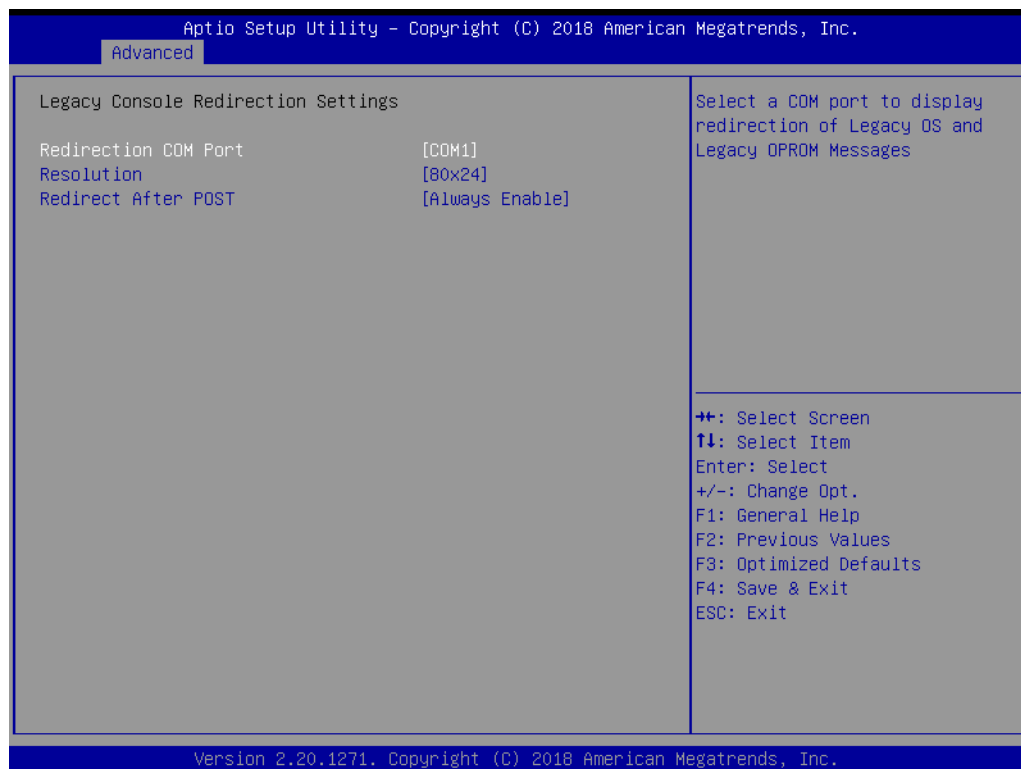

- Redirection COM Port [COM1]
- Resolution [80x24]
- Redirect After POST [Always Enable]

### 3.2.2.13 Intel TXT Information

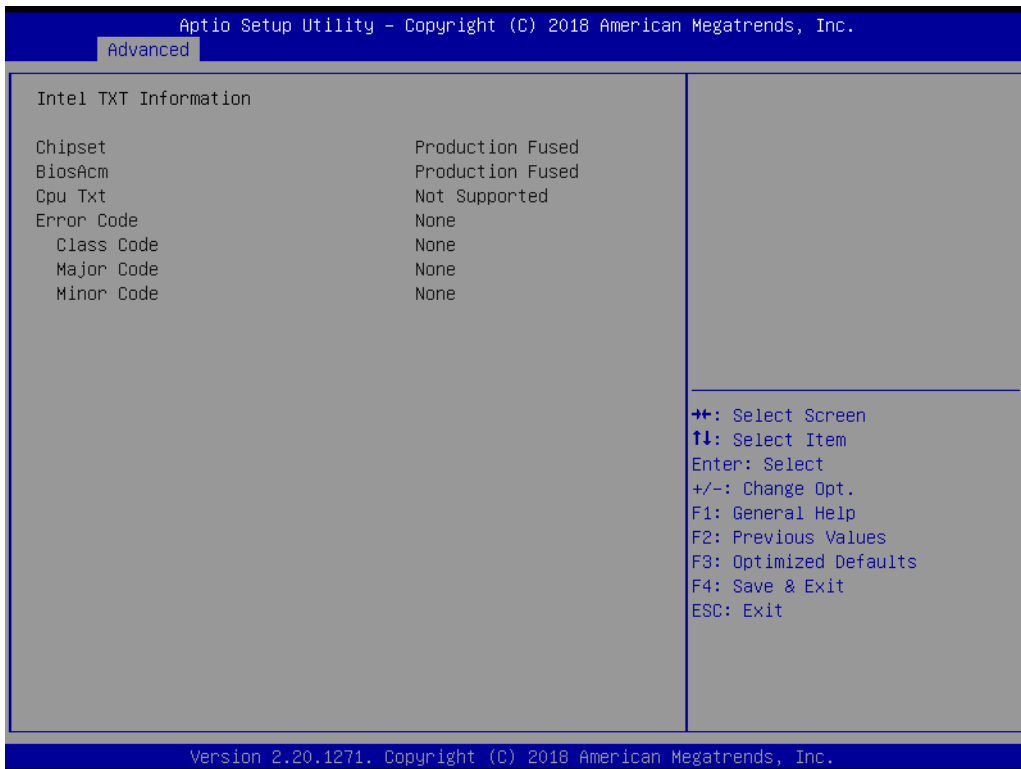
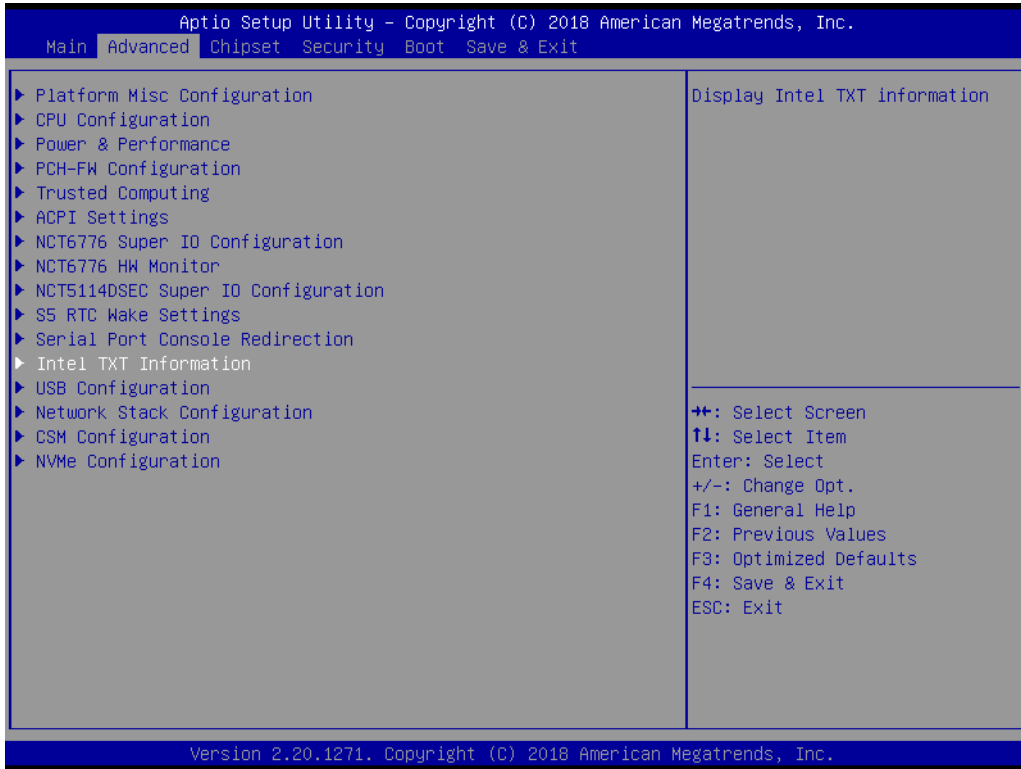

### 3.2.2.14 USB Configuration

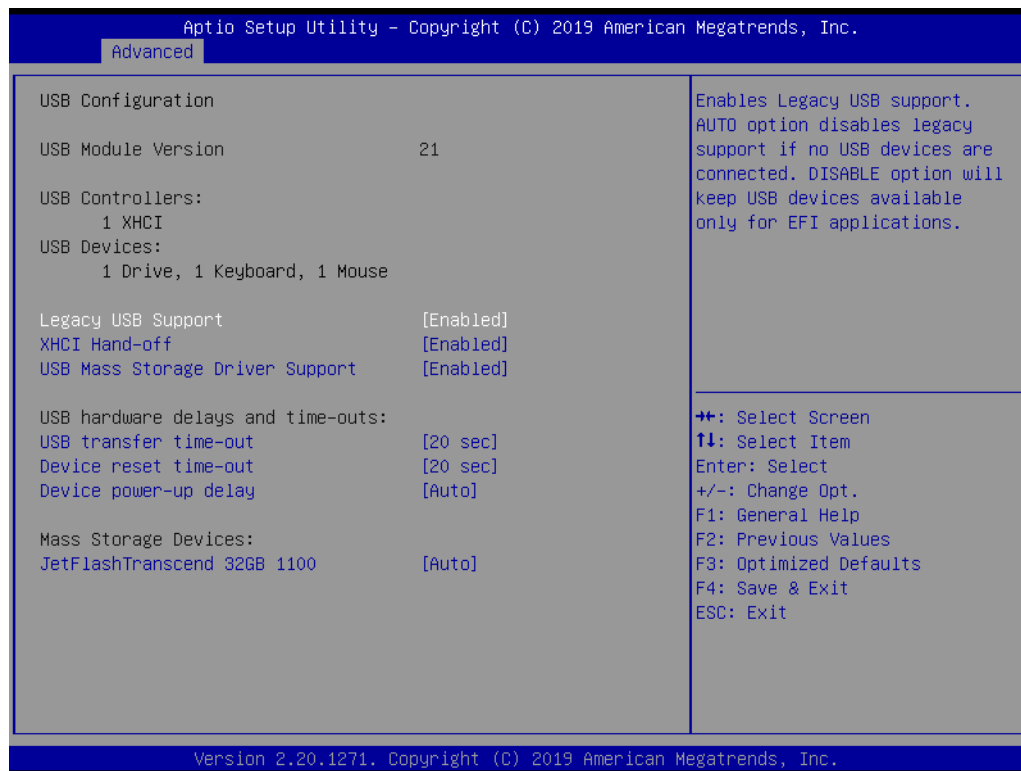
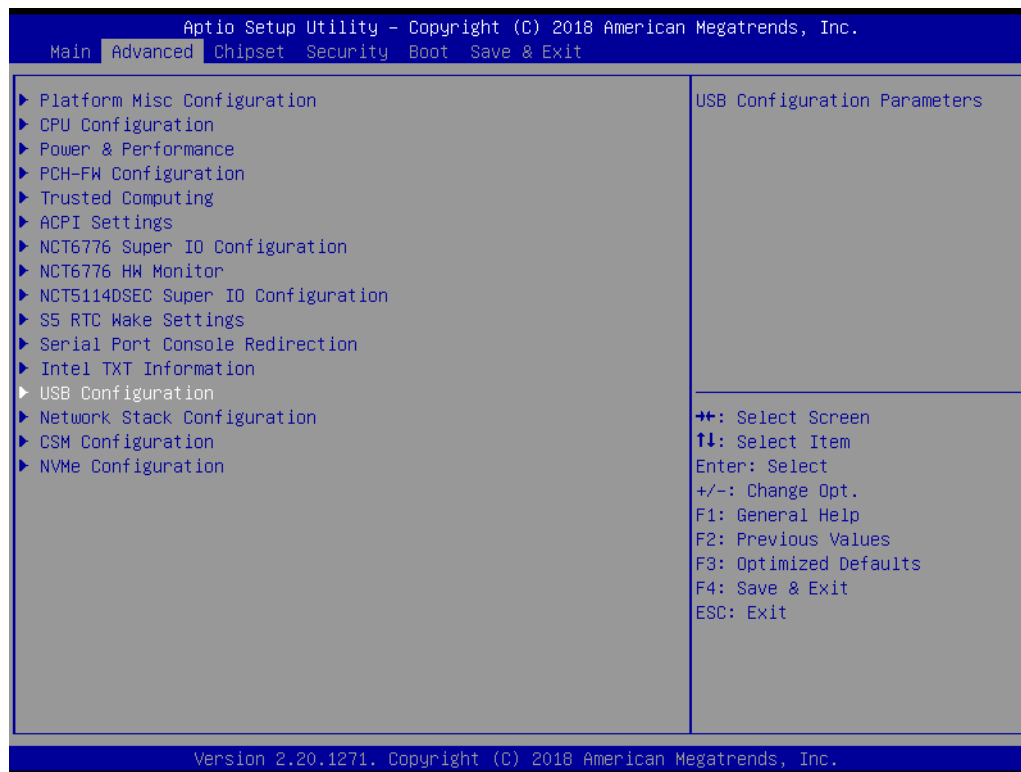

- Legacy USB Support [ Enabled ]
- XHCI Hand-off [ Enabled ]
- USB Mass Storage Driver Support [ Enabled ]
- USB transfer time-out [ 20 sec ]
- Device reset time-out [ 20 sec ]



- Device power-up delay [ Auto ]
- JetFlashTranscend 32GB 1100 [ Auto ]

### 3.2.2.15 Network Stack Configuration

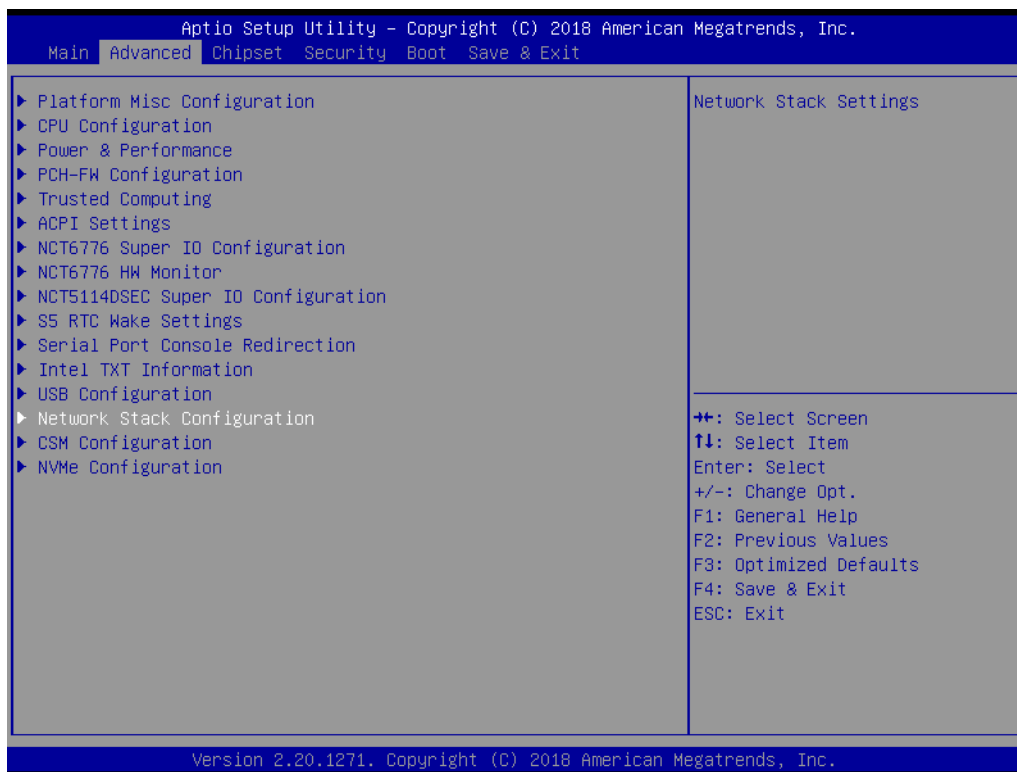

- Network Stack [Disabled]

### 3.2.2.16 CSM Configuration

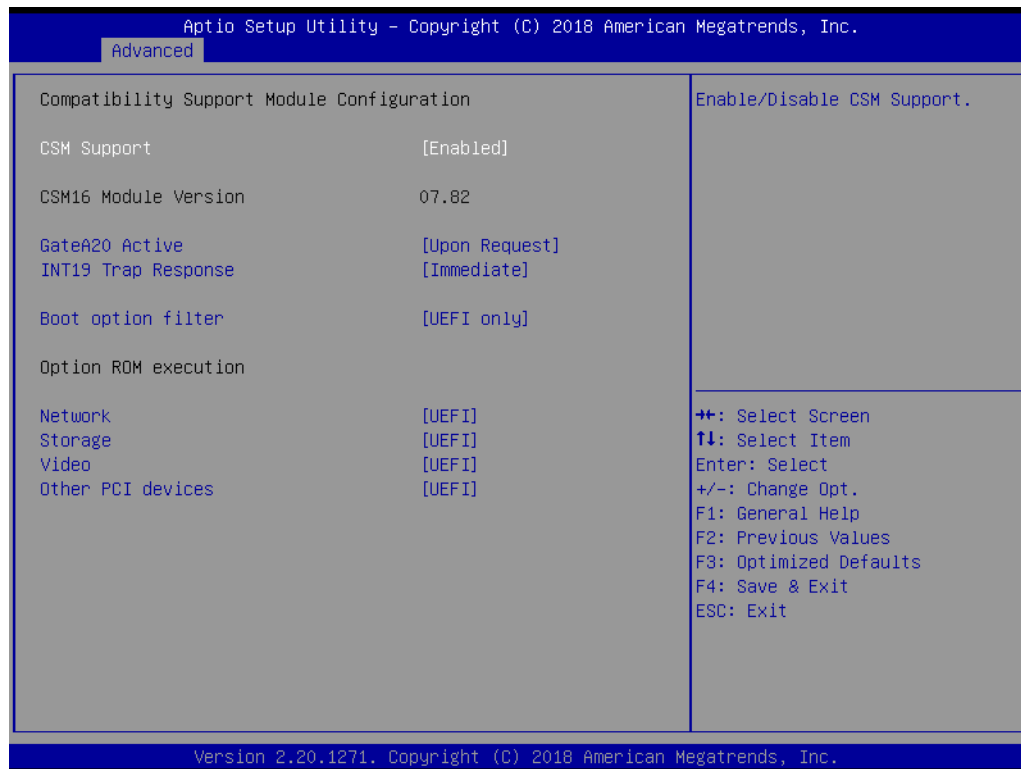
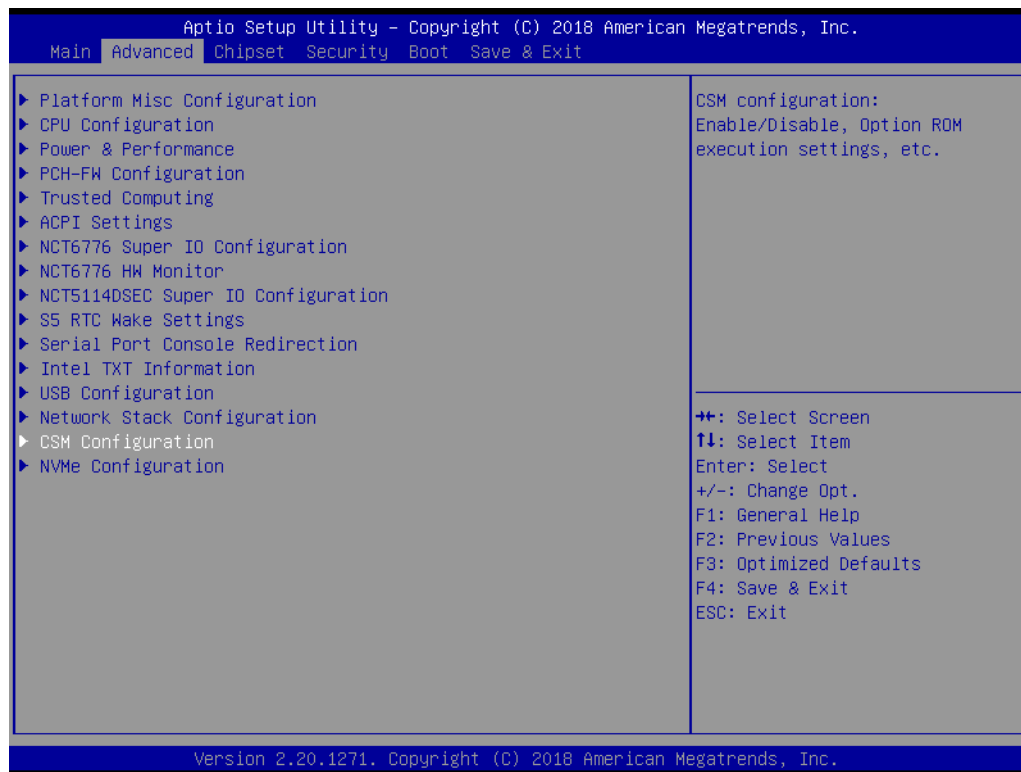

- CSM Support [ Enabled ]
- GateA20 Active [ Upon request ]
- INT19 Trap Response [Immediate ]
- Boot option filter [ UEFI only ]
- Network [UEFI]

- Storage [UEFI]
- Video [UEFI]
- Other PCI device [UEFI]]

**Note!** *If your HDD or other boot device is installed as Legacy mode, it may cause a blue screen crash. There are 2 ways to solve this:*



1. *Re-install your OS as UEFI Mode*
2. *Change all of settings above as "Legacy"*
  - \* *Boot option filter-> Legacy Only*
  - \* *Network -> Legacy*
  - \* *Storage -> Legacy*
  - \* *Video -> Legacy*
  - \* *Other PCI devices -> Legacy*

### 3.2.3 Chipset Configuration Setting

Select the chipset tab from the BIOS setup screen to enter the Chipset Setup screen. Users can select any item in the left frame of the screen, such as PCI express Configuration, to go to the sub menu for that item. Users can display a Chipset Setup option by highlighting it using the <Arrow> keys. All Chipset Setup options are described in this section. The Chipset Setup screens are shown below. The sub menus are described on the following pages.

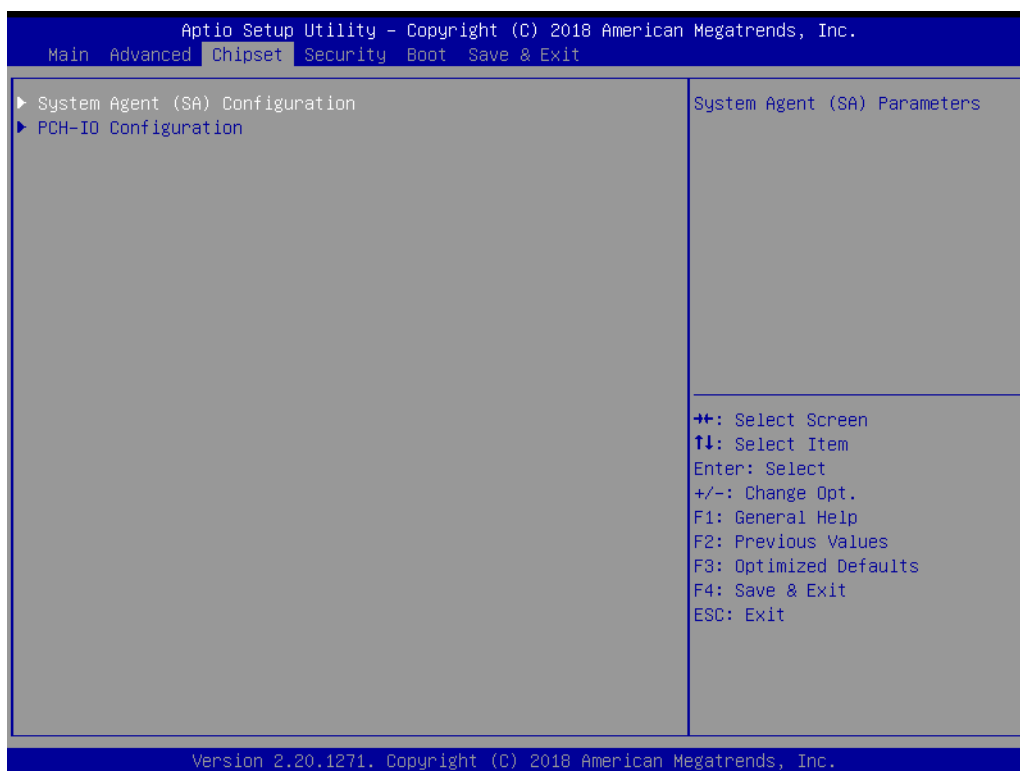

### 3.2.3.1 System Agent (SA) Configuration

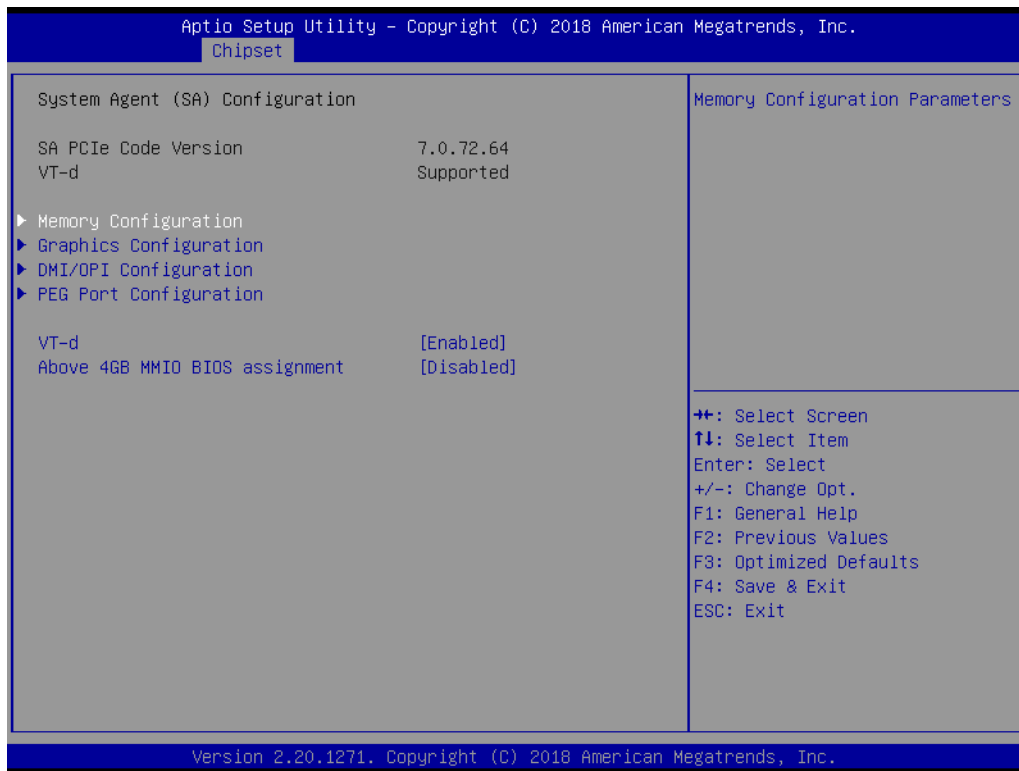

- VT-d [ Enabled ]
- Above 4GB MMIO BIOS assignment [ Disabled ]

### Memory Configuration

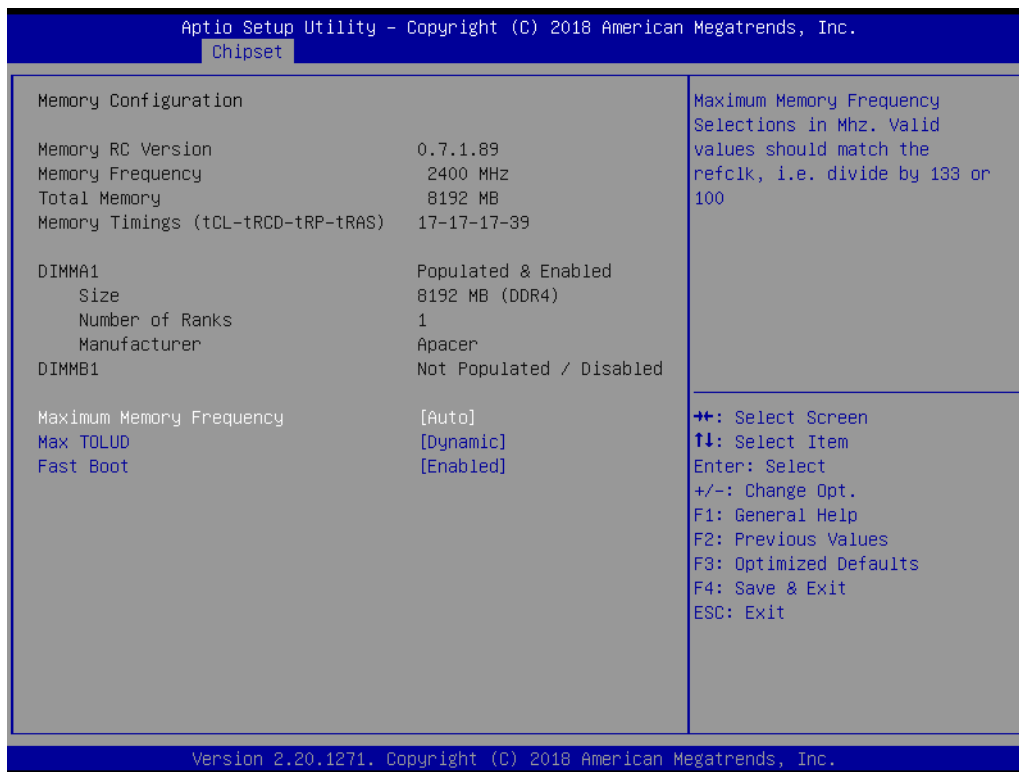

The item shows you memory specification included RC version, Frequency, size and voltage information etc.

- Maximum Memory Frequency (Auto)
- Max TOLUD (Dynamic)  
Maximum Value of TOLUD. Dynamic assignment would adjust TOLUD automatically based on largest MMIO length of installed graphic controller.
- Fast Boot [Enabled]  
Enable or disable Fast Boot support.



## Graphics Configuration



- Skip Scanning of External Gfx Card [disabled]
- Primary Display [ Auto ]  
Select which of IGFX/PEG/PCI Graphics device should be Primary Display
- Select PCIE Card [ Auto ]
- Internal Graphics [ Auto ]  
Keep IGD enabled based on the setup options.
- GTT size [8MB]
- Aperture Size [ 256MB ]
- DVMT Pre-Allocated [ 32M ]  
Select DVMT 5.0 Pre-Allocated (Fixed) Graphics Memory size used by the Internal Graphics Device.
- DVMT Total Gfx Mem [ 256M ]  
Select DVMT5.0 Total Graphic Memory size used by the Internal Graphics Device.
- PM Support [ Enabled ]
- PAVP [ Enabled ]

## LCD Control

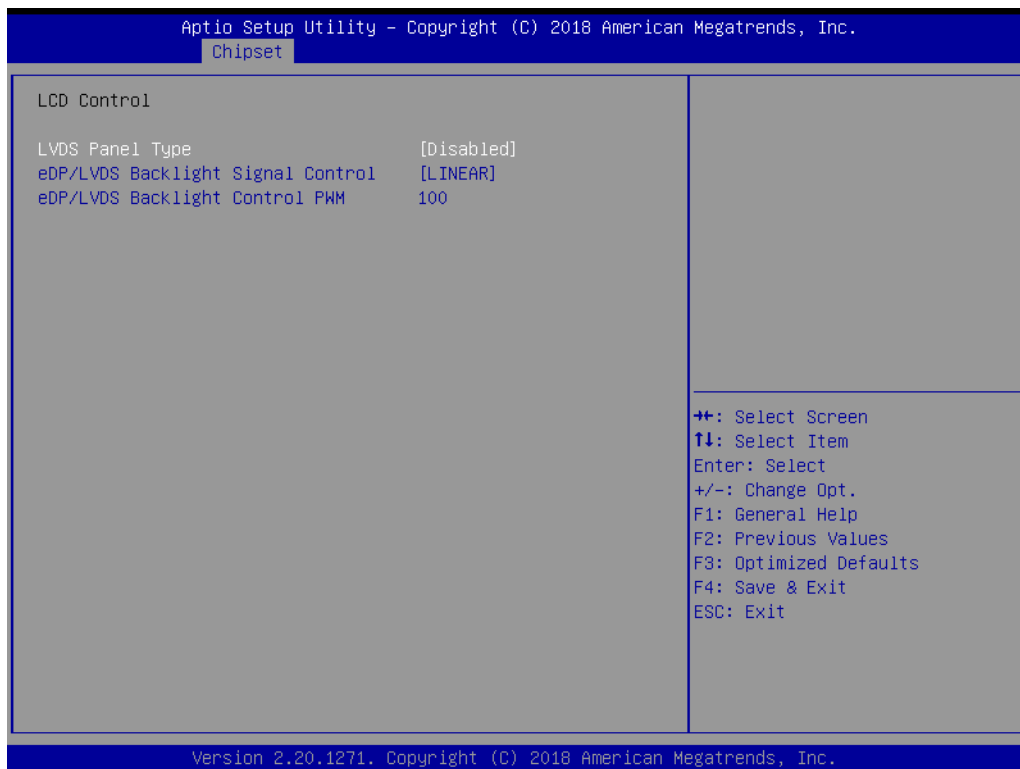

- LVDS Panel Type [ Disabled ]
- eDP/LVDS Backlight Signal Control [ LINEAR ]

## DMI/OPI Configuration

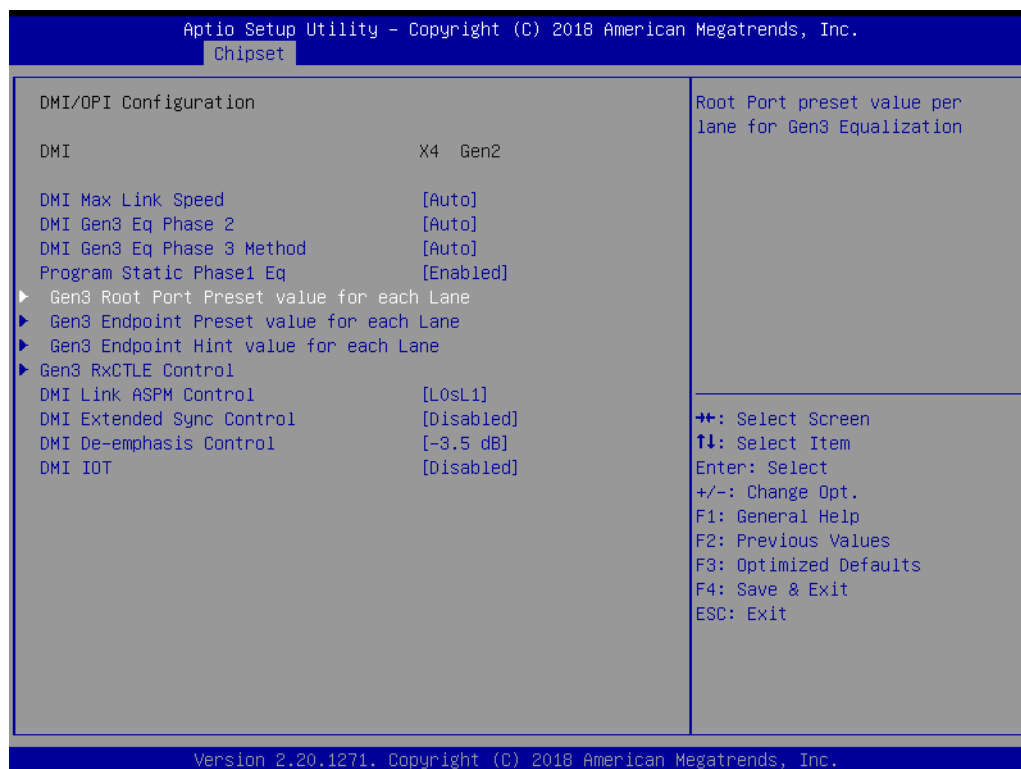
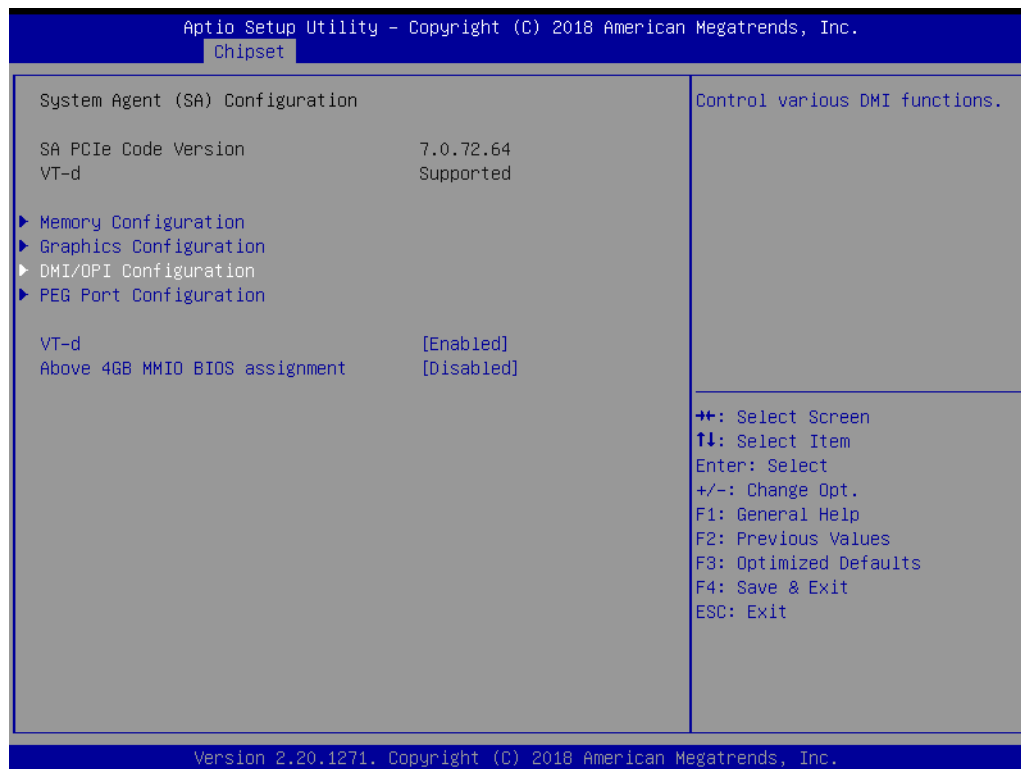

- DMI Max Link Speed [Auto]
- DMI Gen3 Eq Phase 2 [Auto]
- DMI Gen3 Eq Phase 3 Method [Auto]
- Program Static Phase1 Eq [Enabled]
- DMI Link ASPM Control [L0S11]



- DMI Extended Sync Control [Disabled]
- DMI De-emphasis Control [-3.5 dB]
- DMI IOT [Disabled]

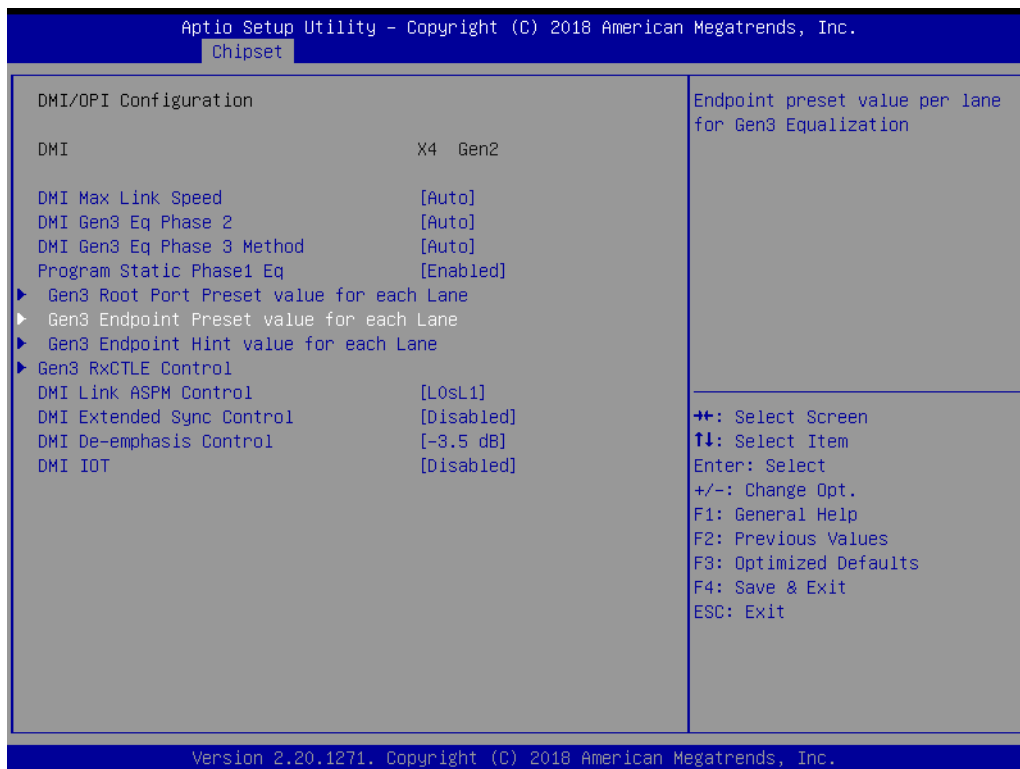

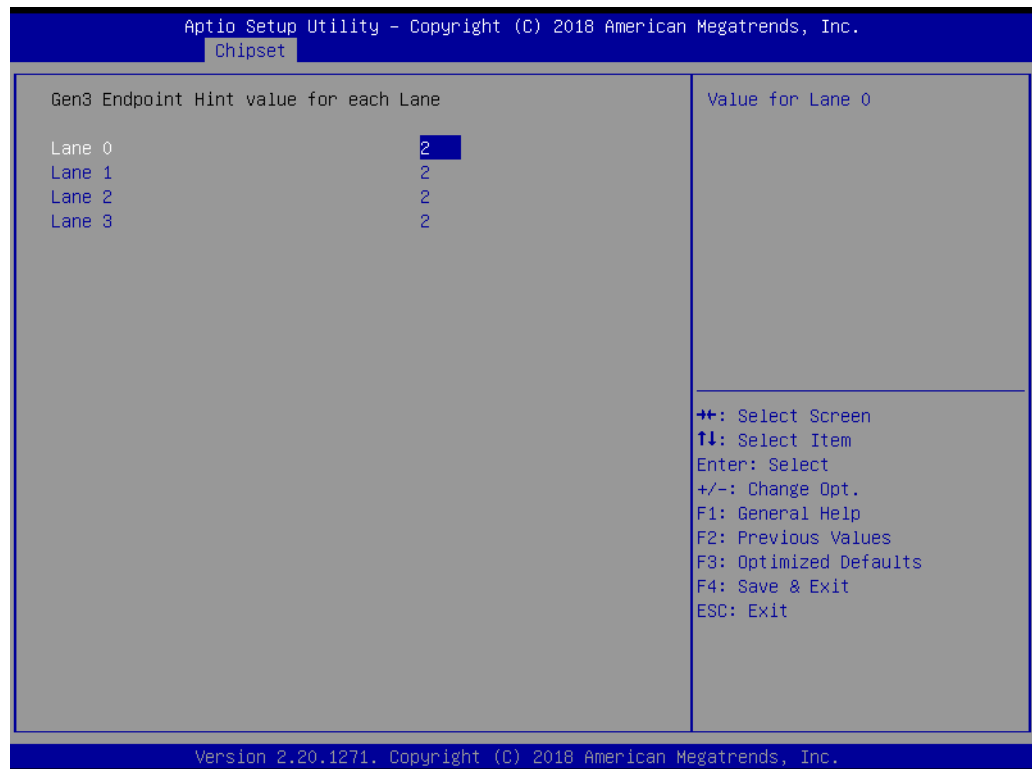
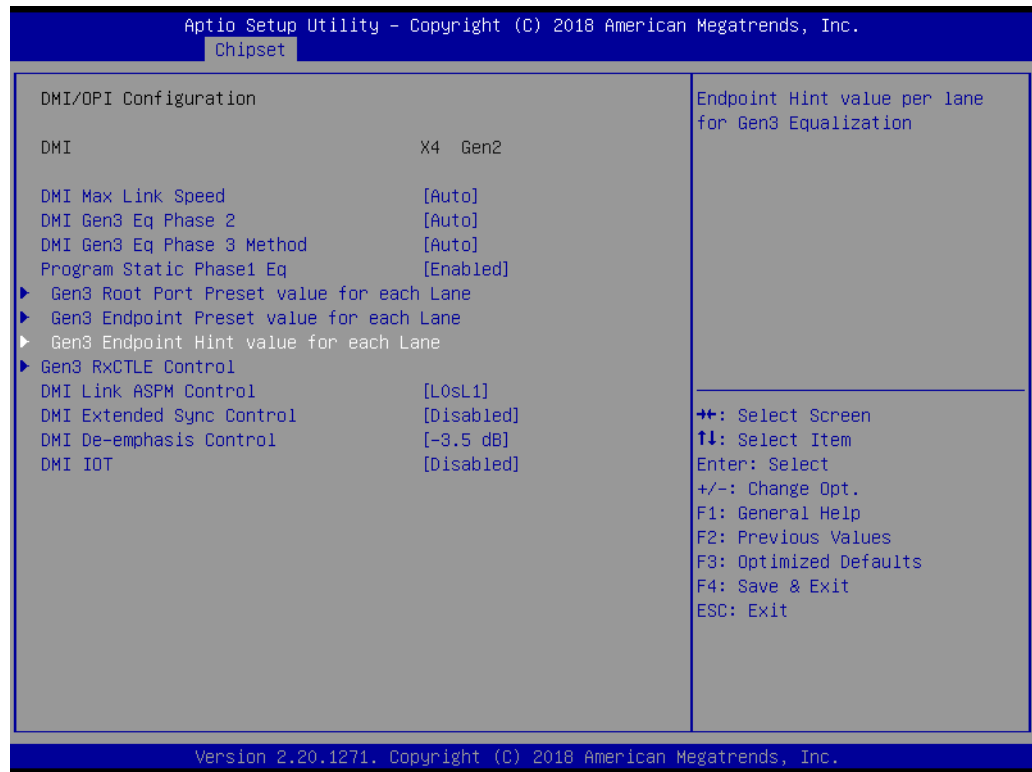

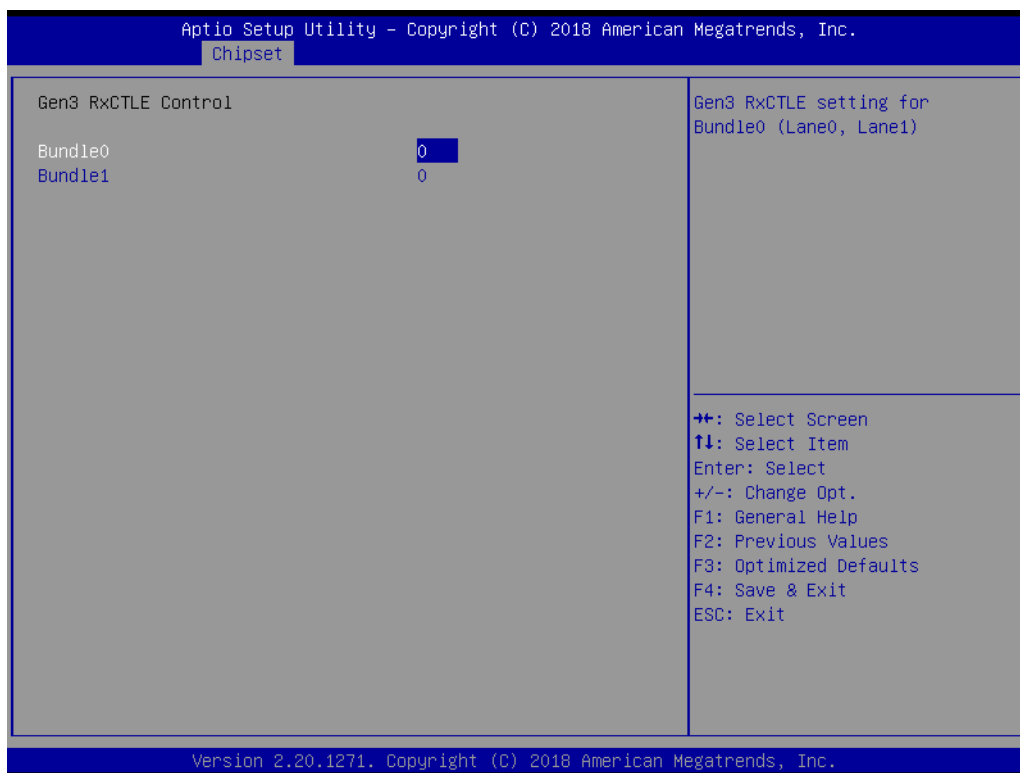

## PEG Port Configuration

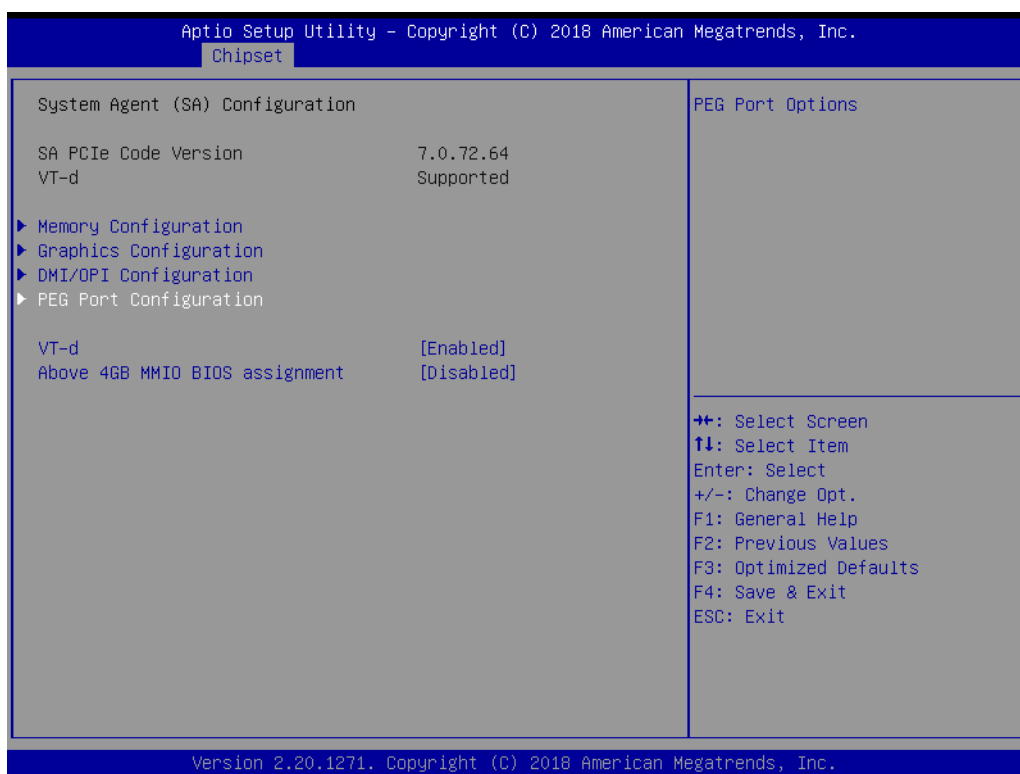

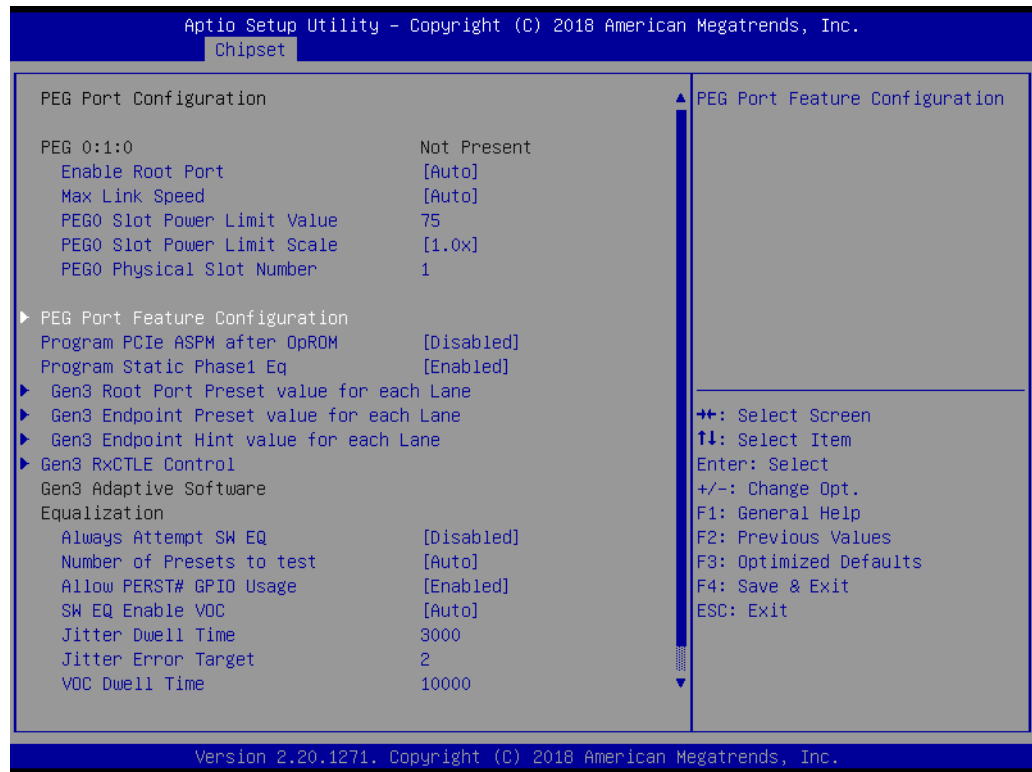

- Enable Root Port [ Auto ]
- Max Link Speed [Auto]
- PEG0 Slot Power Limit Scale [1.0x]
- Program PCIe ASPM after OpROM [ Disabled ]  
 Enabled: PCIe ASPM will be programmed after OpROM.  
 Disabled: PCIe ASPM will be programmed before OpROM.
- Program Static Phase1 Eq [Enabled]
- Always Attempt SW EQ [Disabled]
- Number of Presets to test [Auto]
- Allow PERST# GPIO Usage [Enabled]
- SW EQ Enable VOC [Auto]

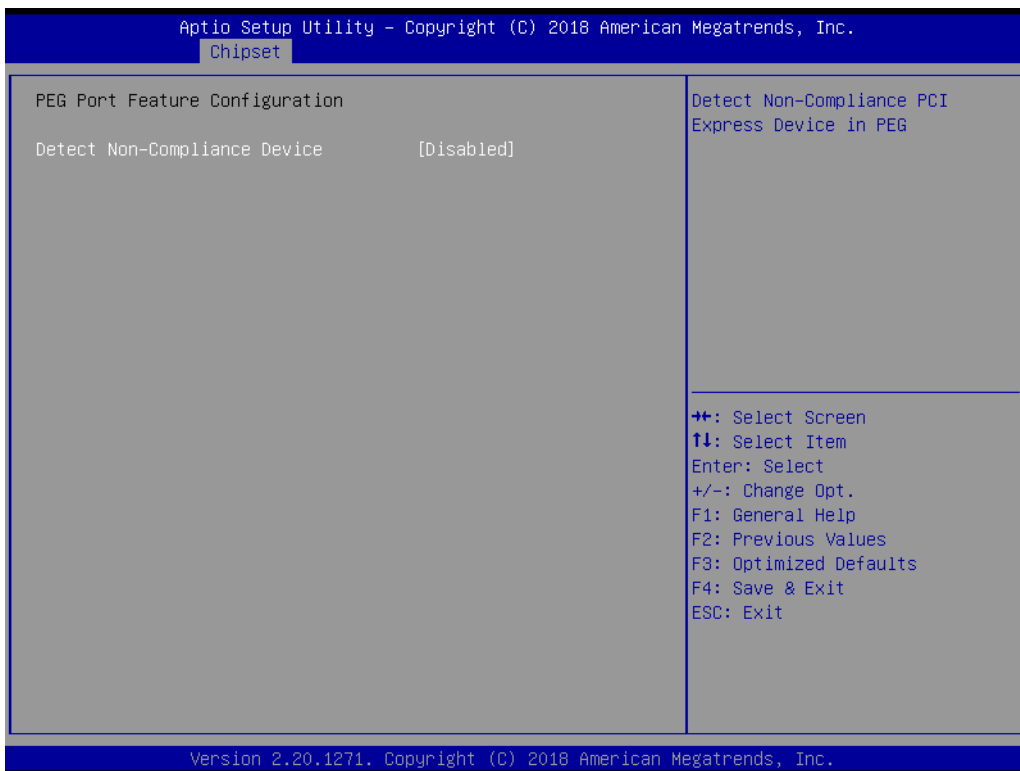

■ Detect Non-Compliance Device [Disabled]

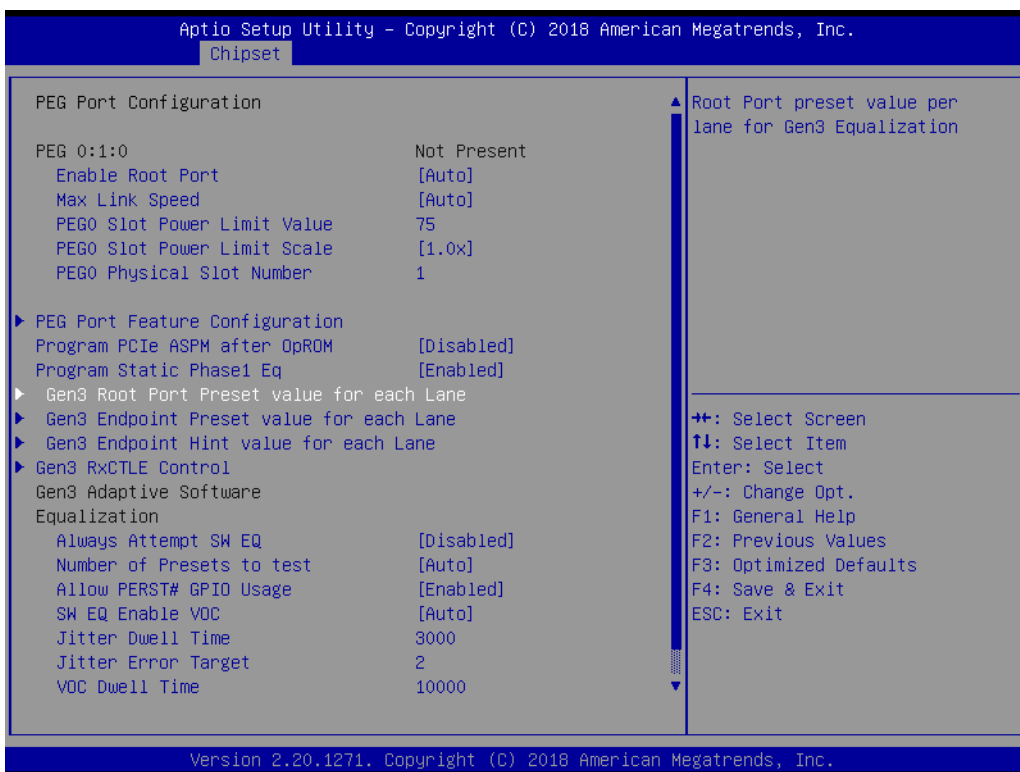

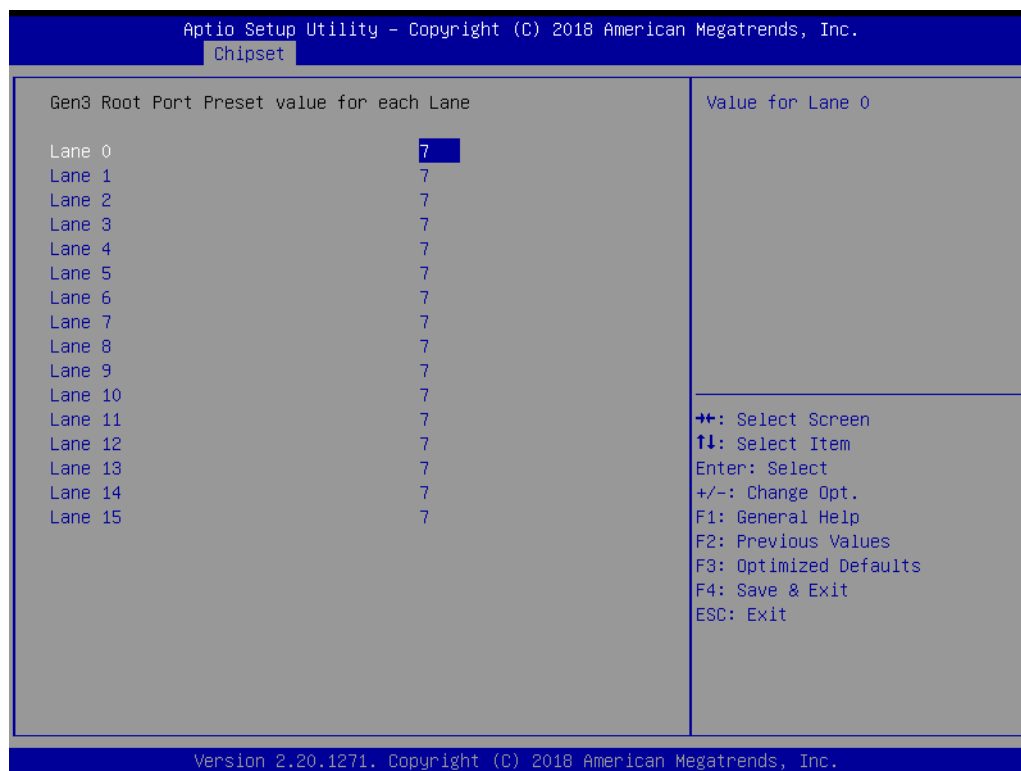

- Gen3 Root Port Preset Value for each Lane  
Root Port Preset Value Per lane for Gen3 Equalization.

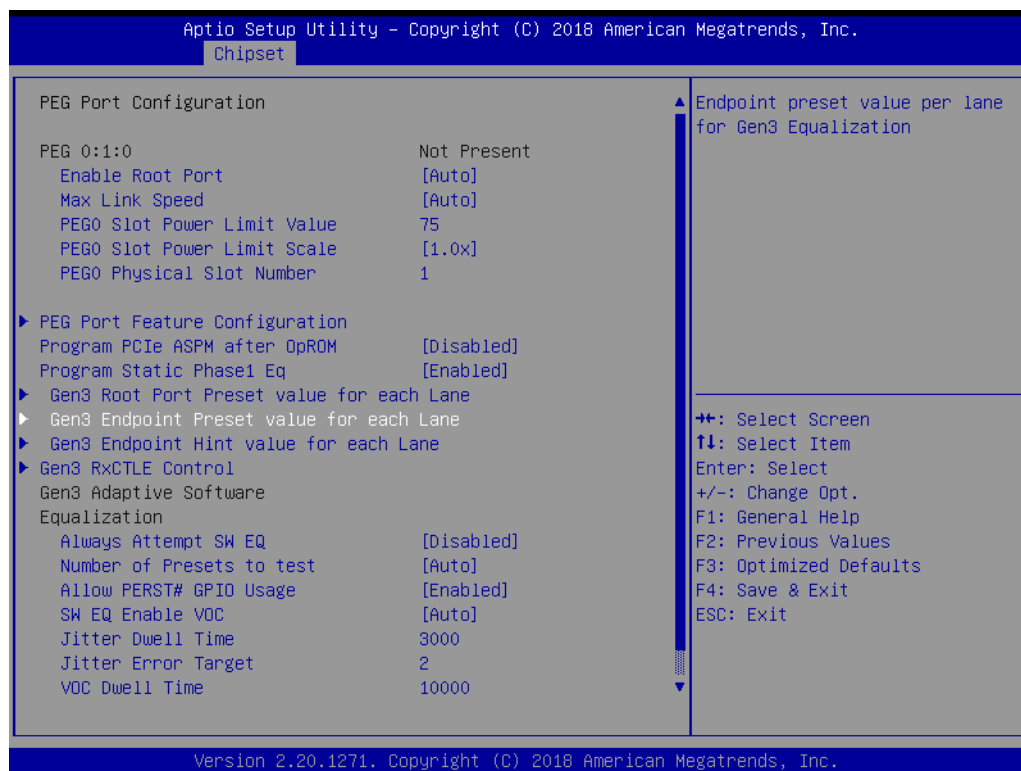

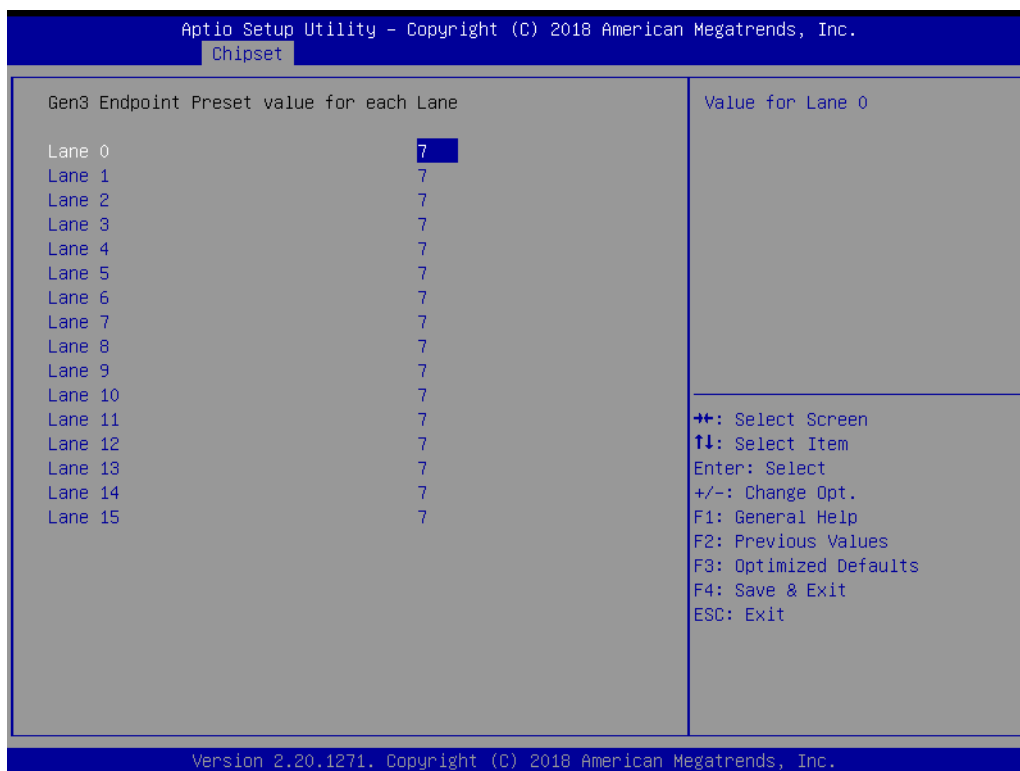

- Gen3 Endpoint Preset Value each Lane  
Endpoint Preset Value Per lane for Gen3 Equalization.

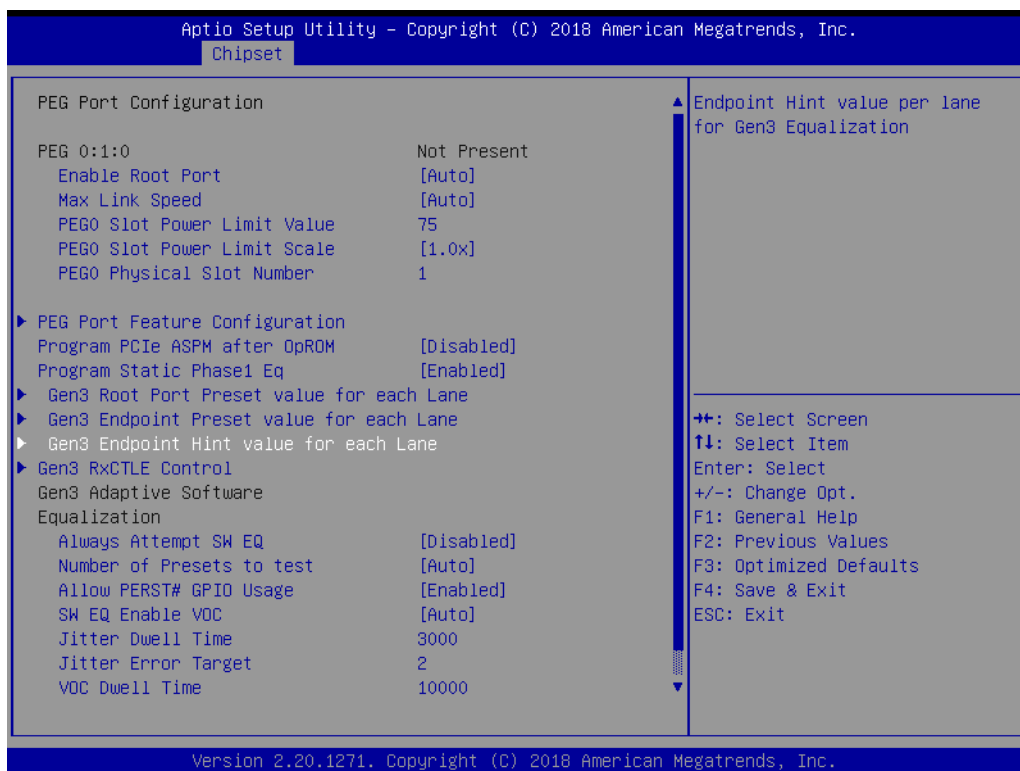

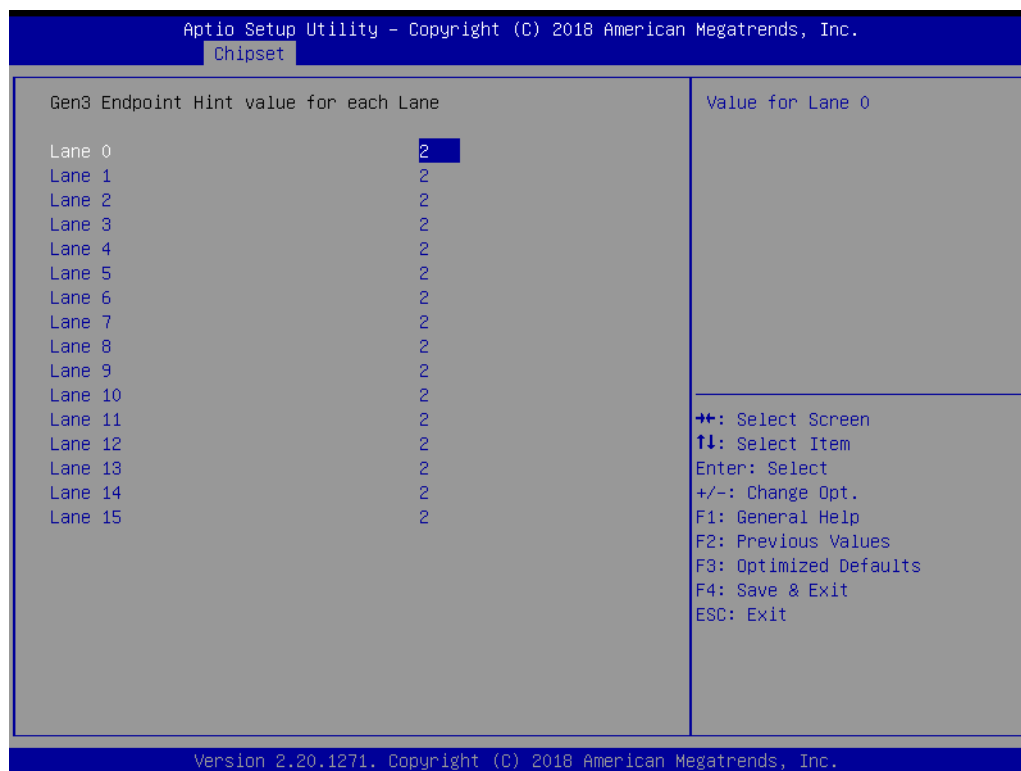

- Gen3 Endpoint Hint Value each Lane  
Endpoint Hint Value Per lane for Gen3 Equalization.

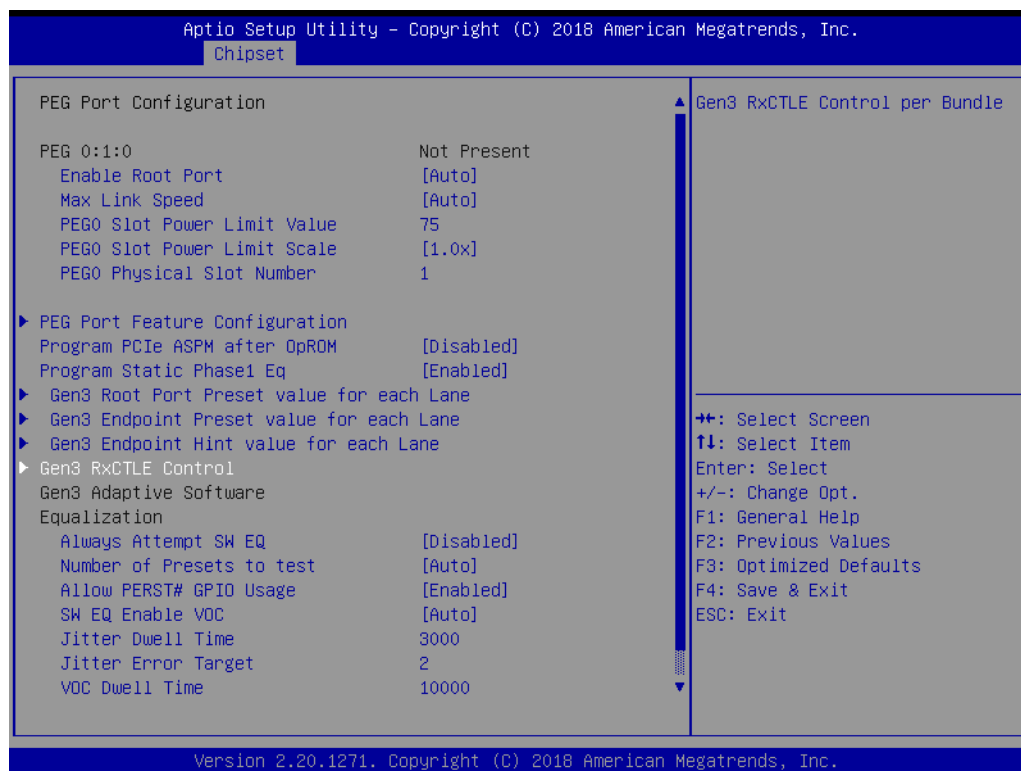



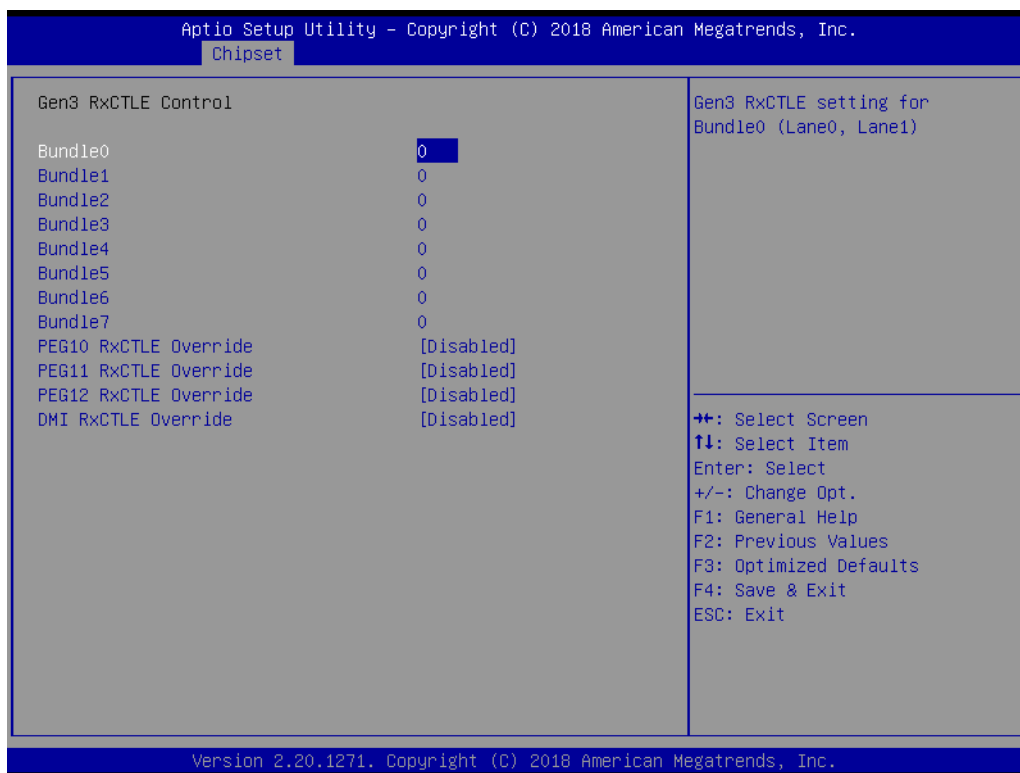

- PEG10 RxCTLE Override [ Disabled ]
- PEG11 RxCTLE Override [ Disabled ]
- PEG12 RxCTLE Override [ Disabled ]
- DMI RxCTLE Override [ Disabled ]

### 3.2.3.2 PCH-IO Configuration

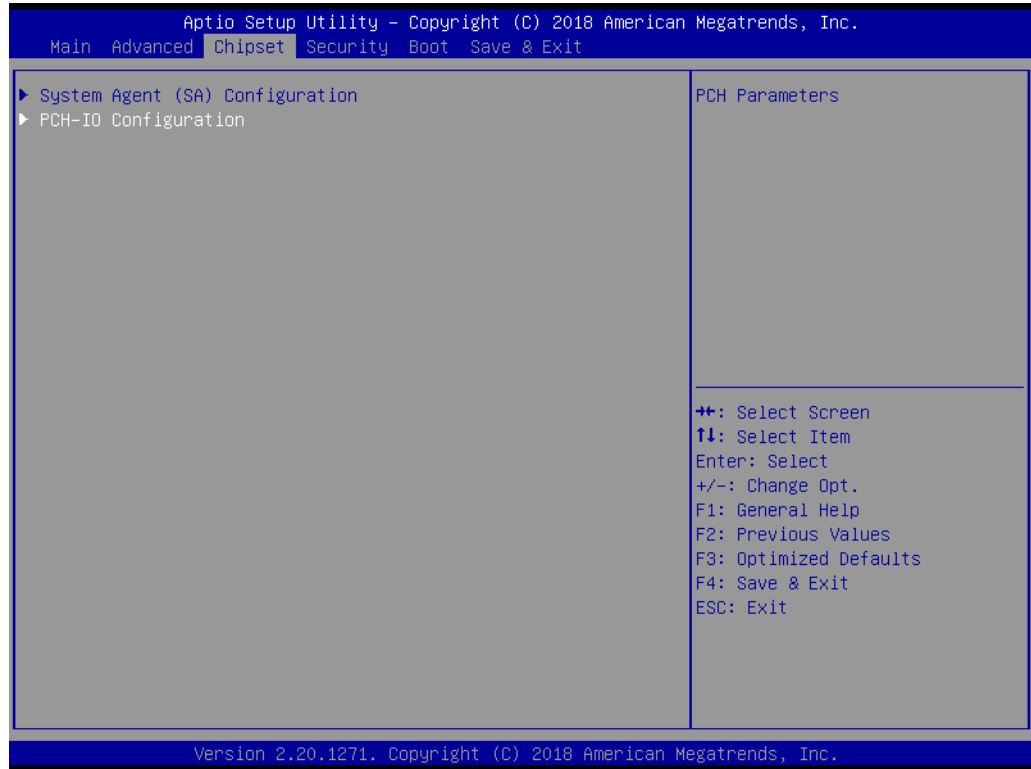

### PCI Express Configuration

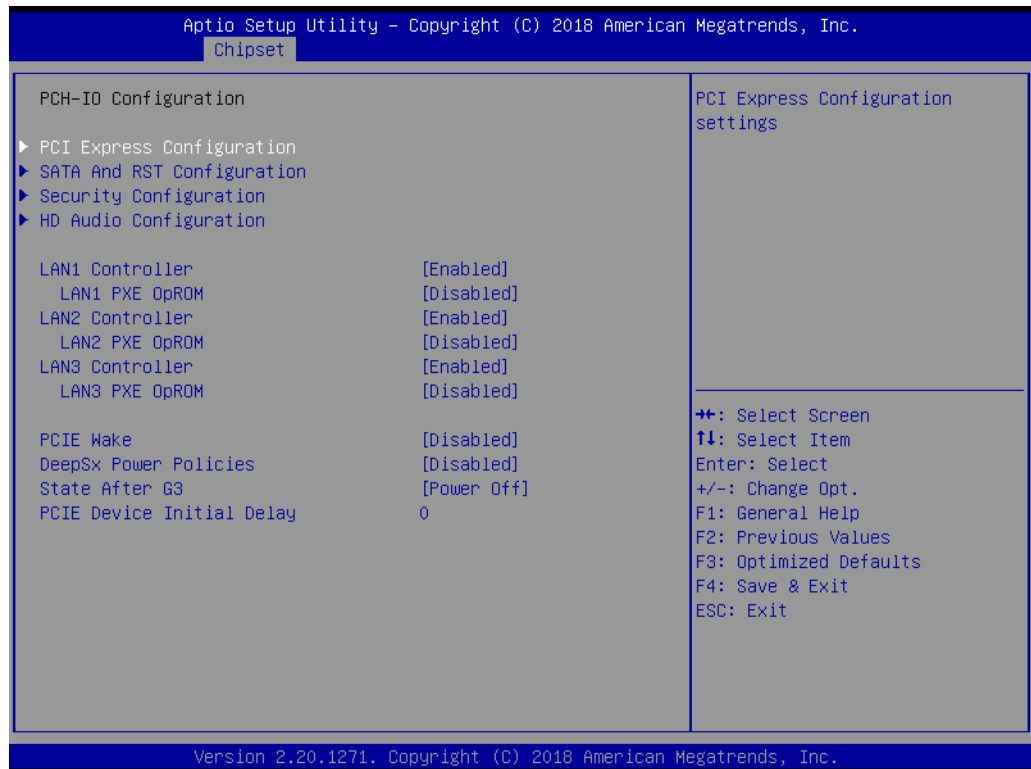

- PCI Express Configuration
- SATA And RST Configuration
- Security Configuration

- HD Audio Configuration
- LAN1 Controller [ Enabled ]  
Enable or disable the LAN1 controller.
- LAN1 PXE OpROM [ Disabled ]  
Enable or disable the LAN1 controller.
- LAN 2 controller [ Enabled ]  
Enable or disable the LAN2 controller.
- LAN2 PXE OpROM [ Disabled ]  
Enable or disable the LAN2 controller.
- LAN3 controller [ Enabled ]  
Enable or disable the LAN3 controller.
- LAN3 PXE OpROM [ Disabled ]  
Enable or disable the LAN3 controller.
- PCIE Wake [ Disabled ]  
Enable or disable PCIE to wake the system from S5.
- DeepSx Power Policies [ Disabled ]
- State After G3 [ Power Off ]  
This item allows users to select off, on and last state.

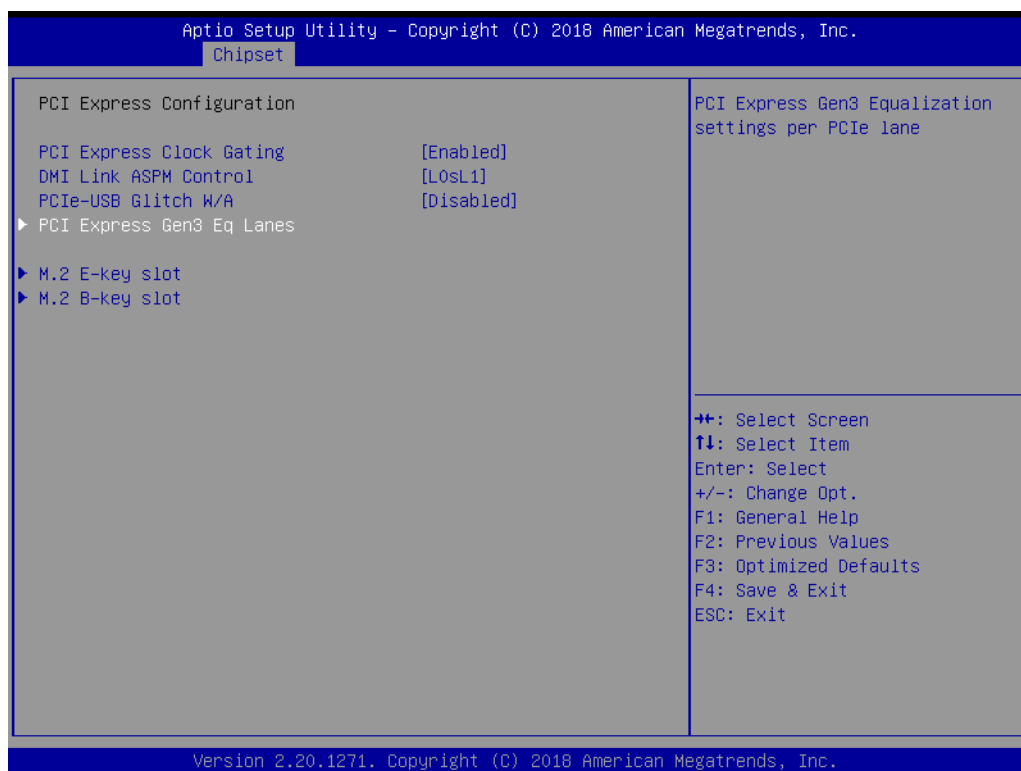

- PCI Express Clock Gating [ Enabled ]  
Enable or Disable PCI Express clock gating for each port.
- DMI Link ASPM Control [ L0sL1 ]
- PCIe-USB Glitch W/A [ Disabled ]  
PCIe-USB Glitch W/A for bad USB device(s) connected behind PCIE/PEG Port.

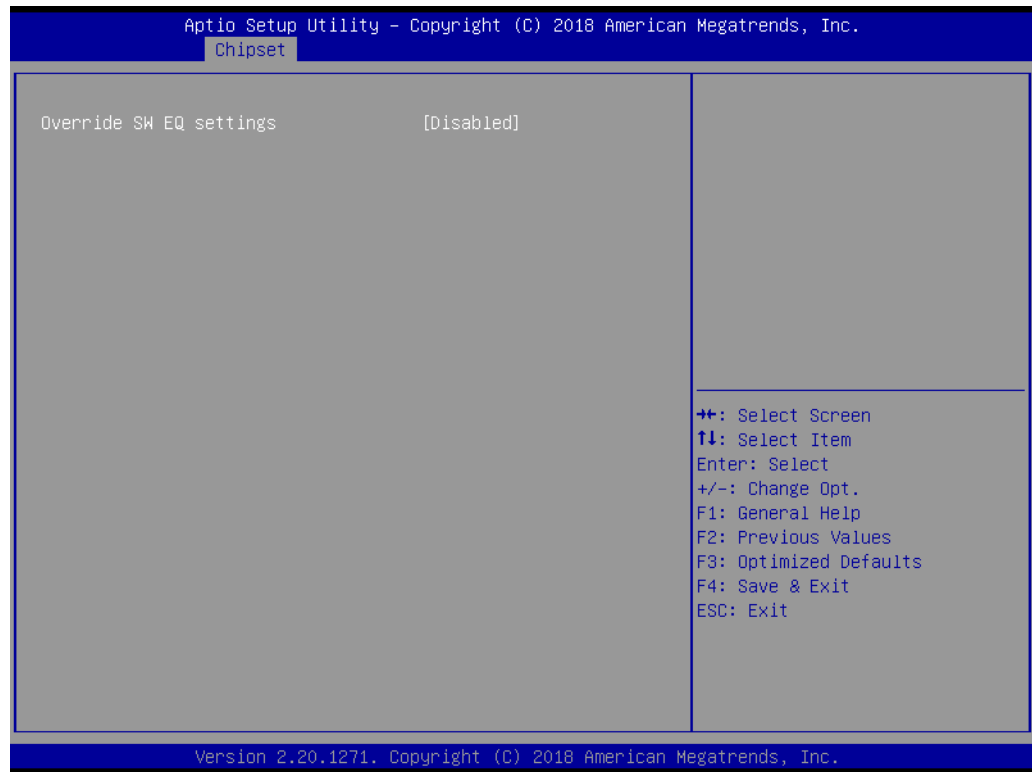

- Override SW EQ Settings [ Disabled ]

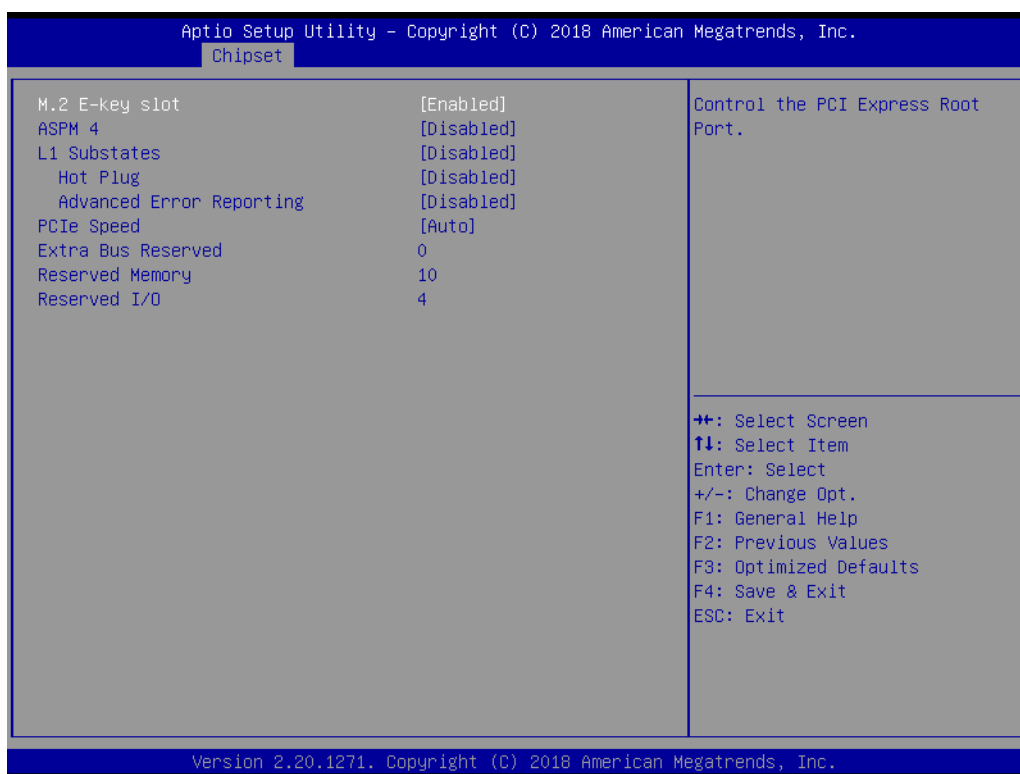
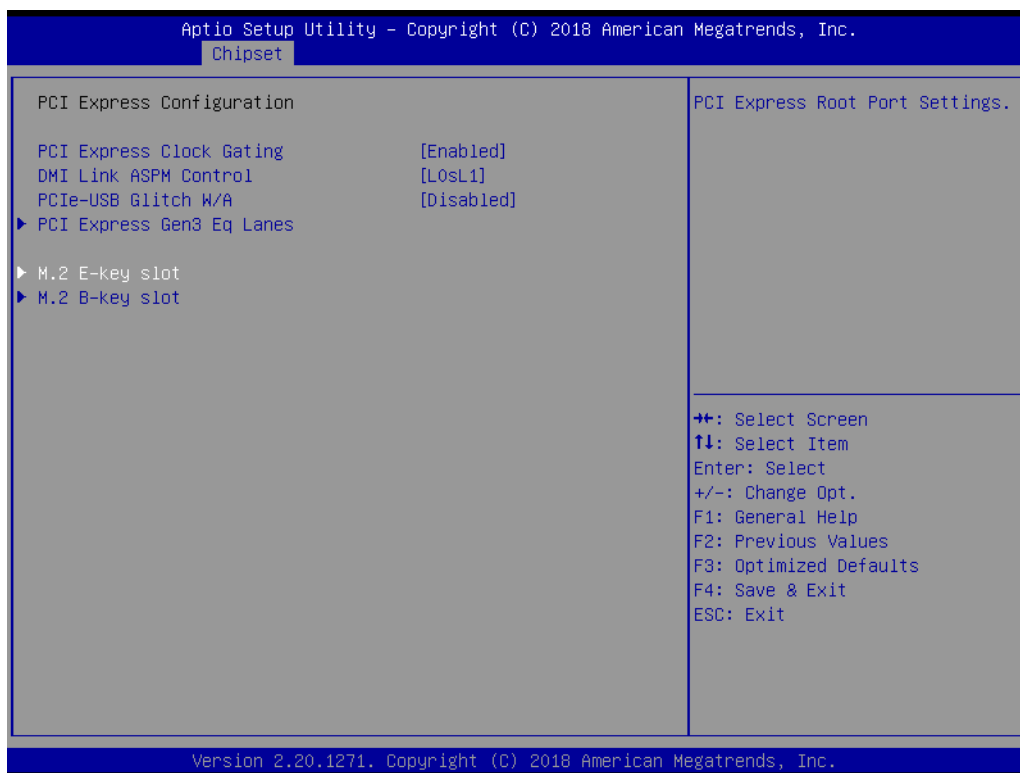

### M.2 E-key slot

- M.2 E-Key slot [ Enabled ]  
Control the M.2 E-Key Root Port.
- ASPM 4 [ Disabled ]  
Set the ASPM Level: Force L0s - Force all links to L0s State : AUTO - BIOS auto configure : DISABLE - Disables ASPM

- L1 Substates [ Disabled ]
- Hot Plug [ Disabled ]
- Advanced Errors Reporting [ Disabled ]
- PCIE Speed [Auto ]

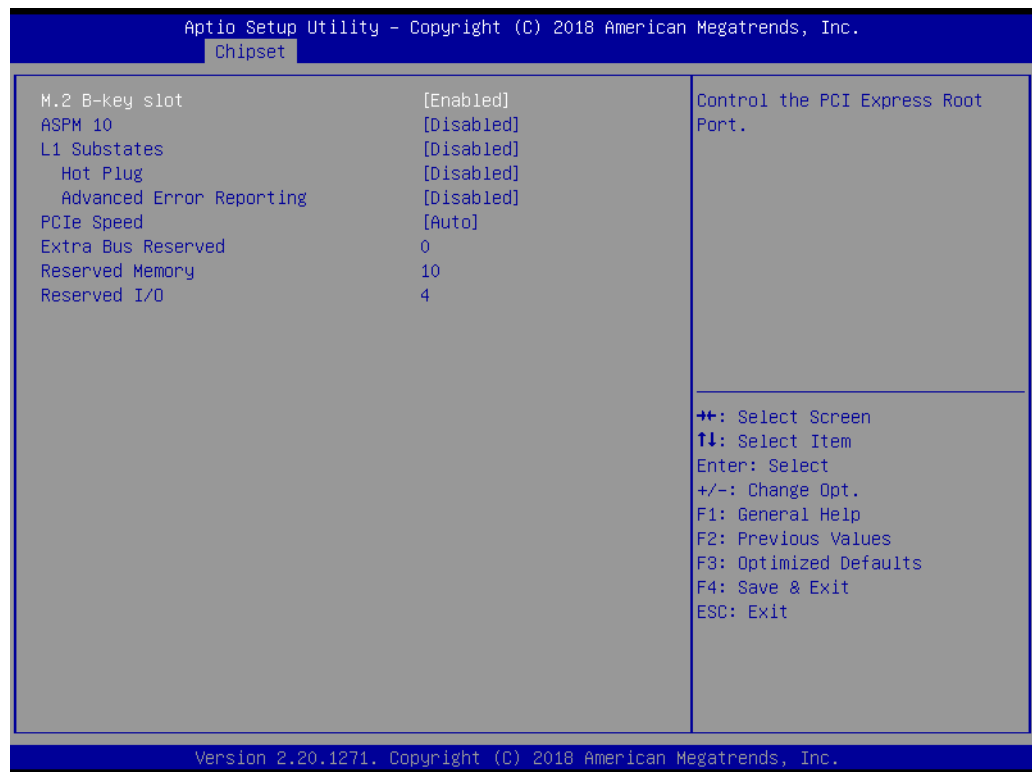

### M.2 B-key slot

- M.2 B-Key slot [ Enabled ]  
Control the M.2 E-Key Root Port.
- ASPM 10 [ Disabled ]  
Set the ASPM Level: Force L0s - Force all links to L0s State : AUTO - BIOS  
auto configure : DISABLE - Disables ASPM
- L1 Substates [ Disabled ]
- Hot Plug [ Disabled ]
- Advanced Errors Reporting [ Disabled ]
- PCIE Speed [Auto ]

## SATA and RST Configuration

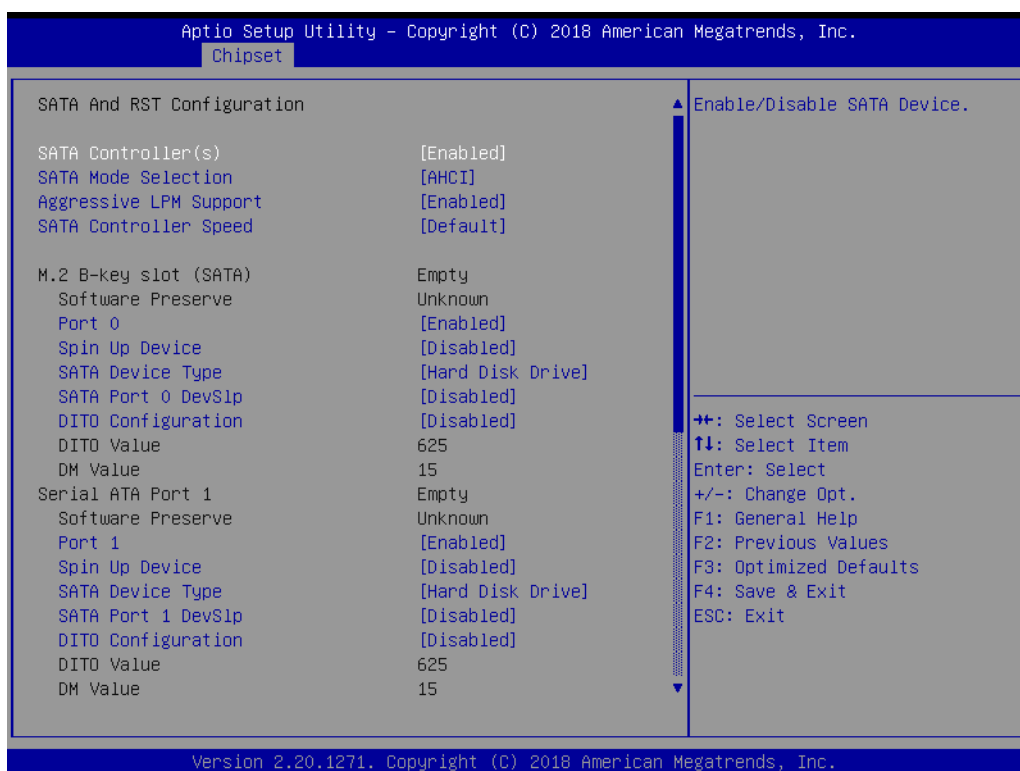
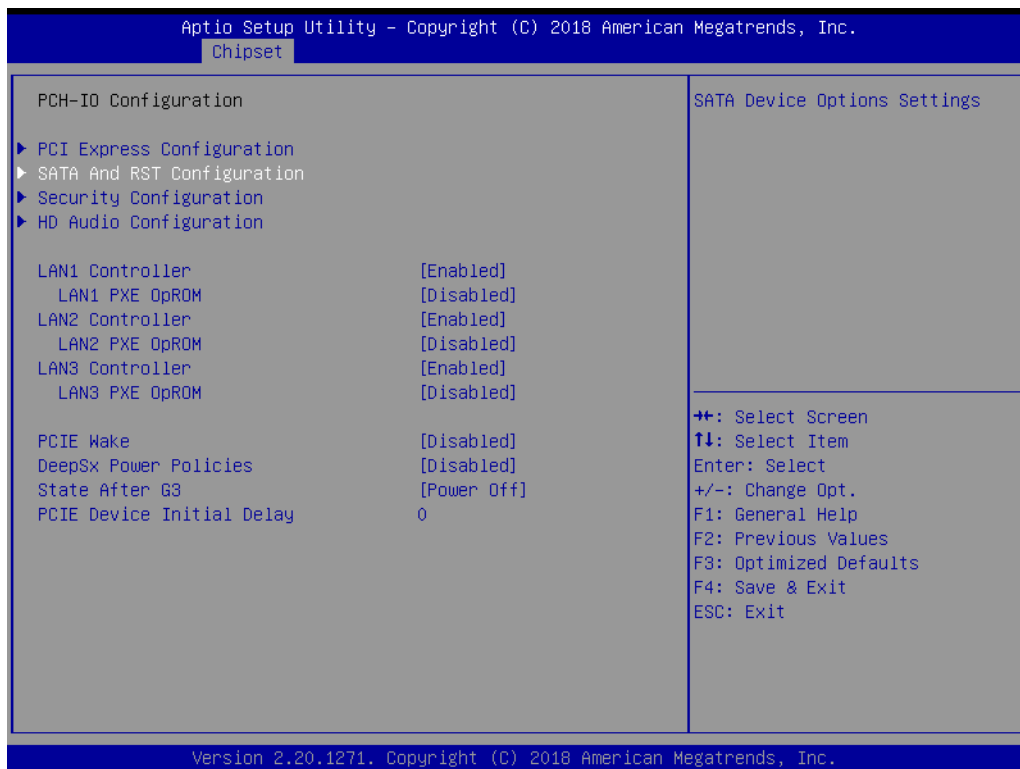

- SATA Controller(s) [ Enabled ]
- SATA Mode Selection [ AHCI ]
- Aggressive LPM Support [ Enabled ]
- SATA Controller Speed [ Default ]

## M.2 B-key slot (SATA)

- Port 0 [Enabled ]
- Spin Up Device [ Disabled ]
- SATA Device Type [ Hard Disk Drive ]
- SATA Port 0 DevS1p [ Disabled]
- DIT0 Configuration [ Disabled ]

## Serial ATA Port 1 (SATA)

- Port 1 [Enabled ]
- Spin Up Device [ Disabled ]
- SATA Device Type [ Hard Disk Drive ]
- SATA Port 1 DevS1p [ Disabled]
- DIT0 Configuration [ Disabled ]

## Security Configuration

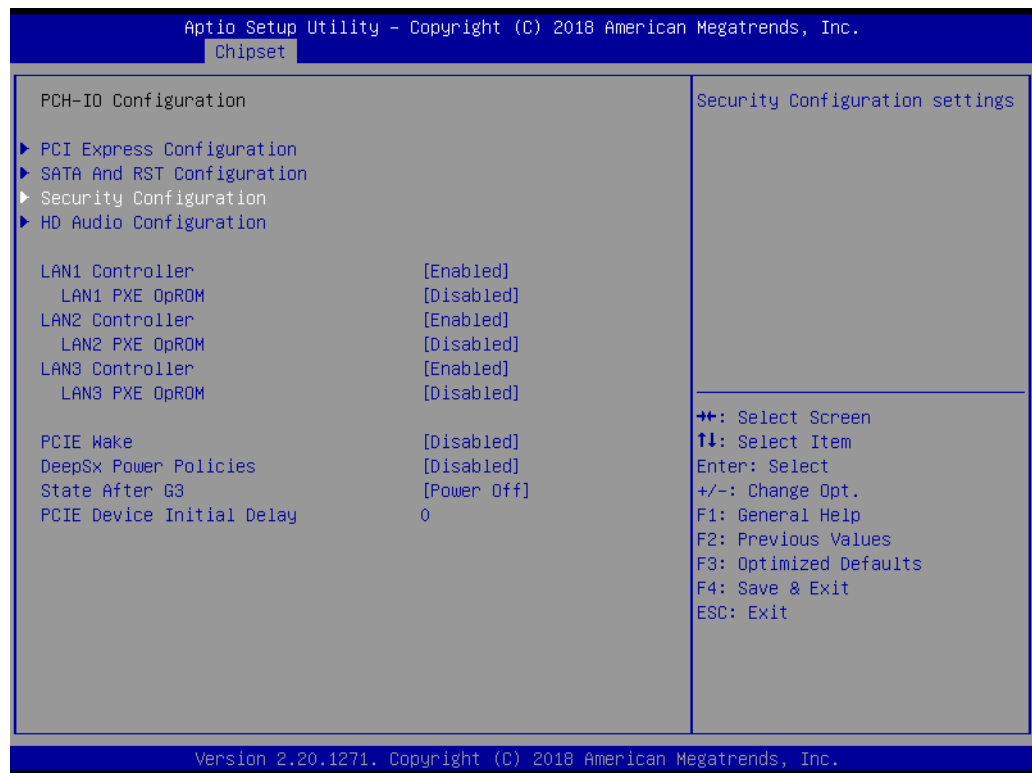





- RTC Memory Lock [ Enabled]
- BIOS Lock [ Enabled]

### HD Audio Configuration

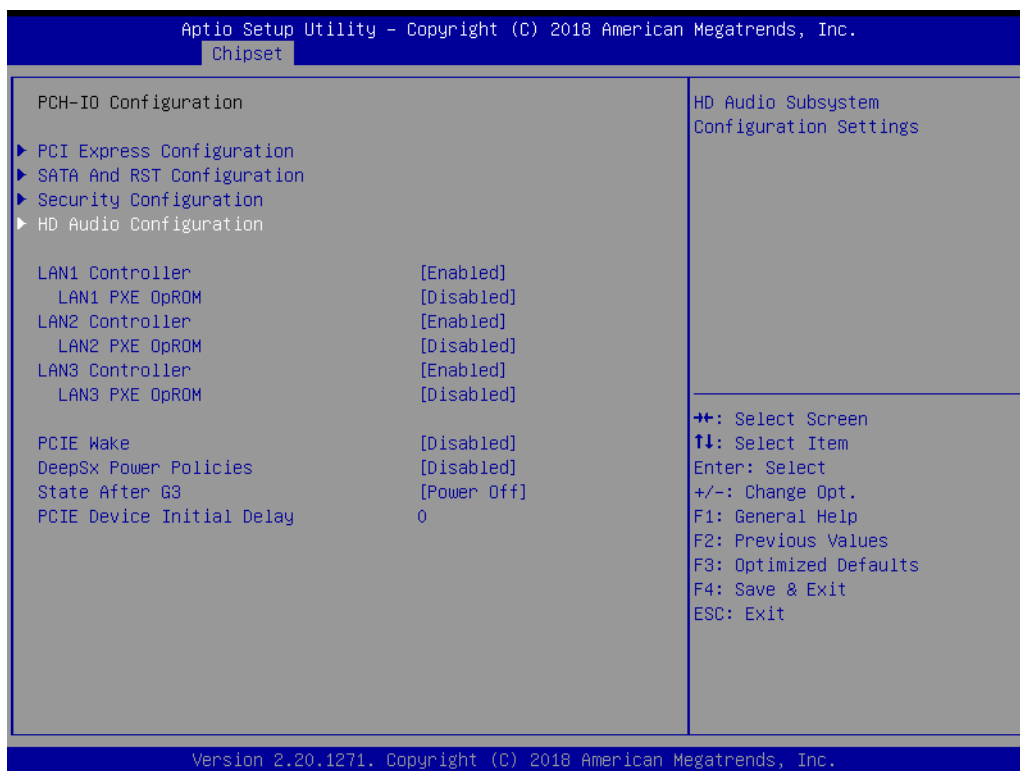

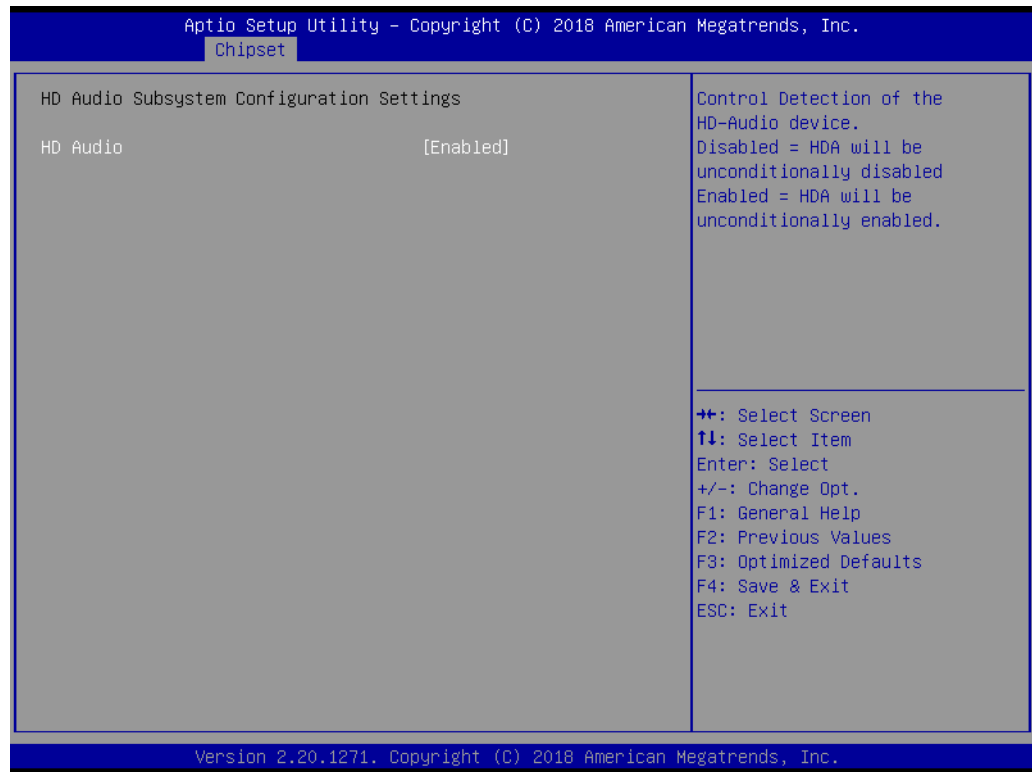

- HD Audio [ Enabled]

### 3.2.4 Security

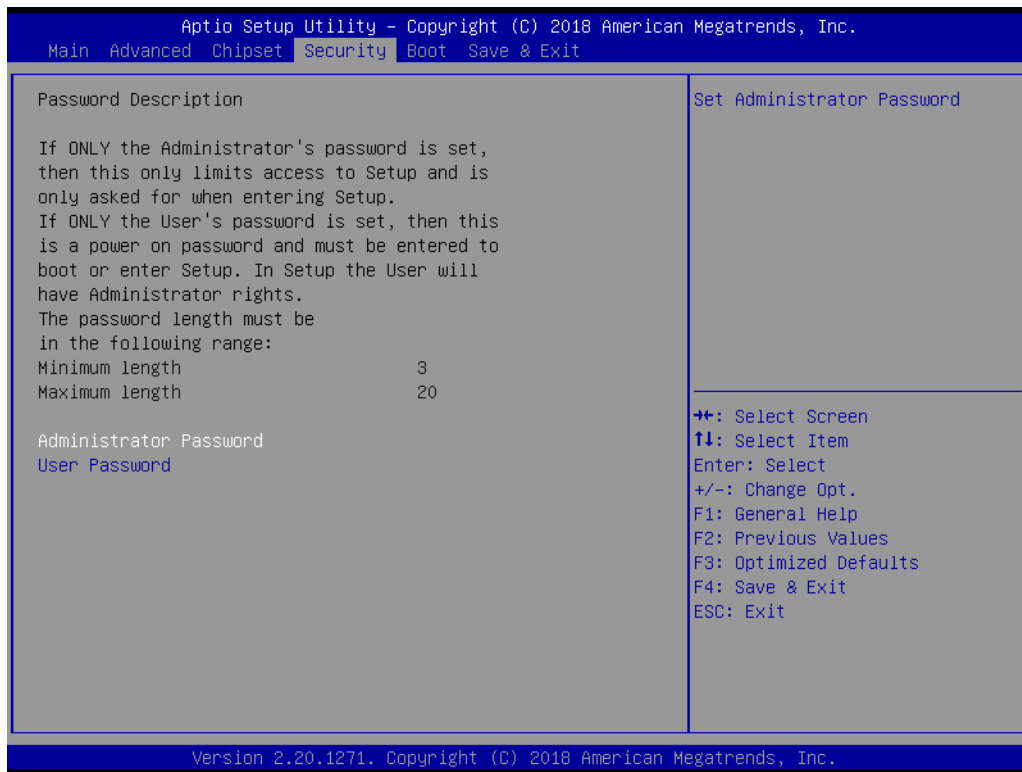

- **Administrator Password**  
Select this option and press <ENTER> to access the sub menu, and then type in the password. Set the Administrator password.
- **User Password**  
Select this option and press <ENTER> to access the sub menu, and then type in the password. Set the User Password.

## 3.2.5 Boot Setting

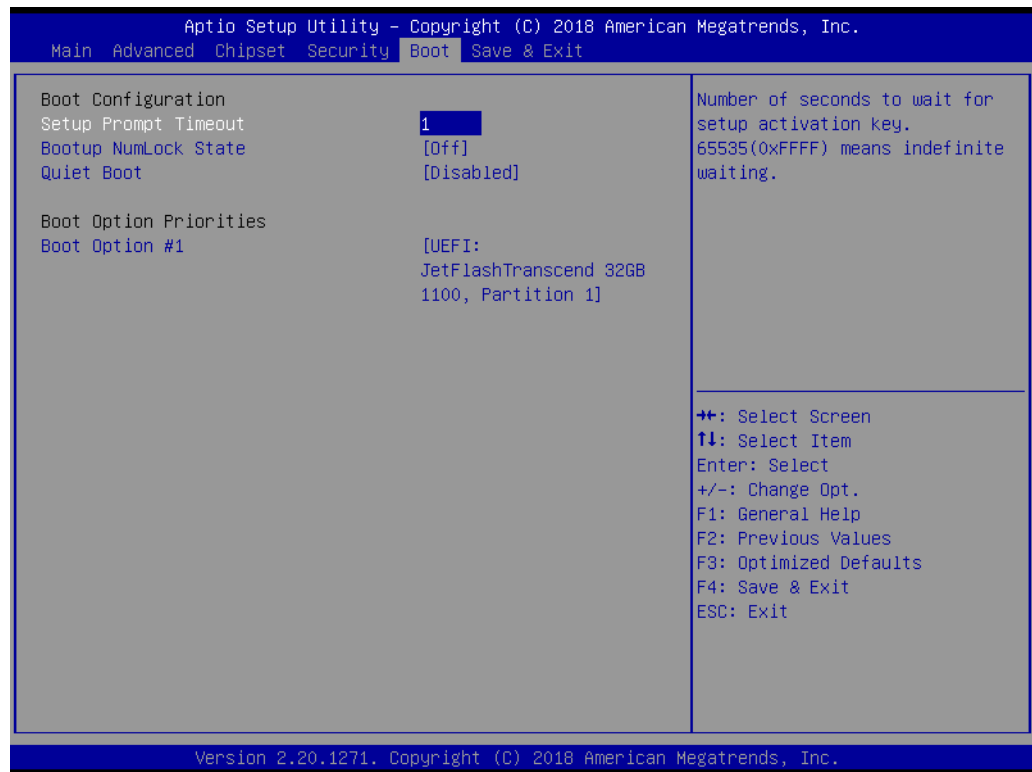

- **Setup Prompt Timeout**  
Use the <+> and <-> keys to adjust the number of seconds to wait for setup activation key.
- **Bootup NumLock State [ Off ]**  
On or Off power on state for the NumLock
- **Quiet Boot [ Disabled ]**  
If this option is set to disabled, the BIOS displays normal POST messages. If enabled, an OEM logo is shown instead of POST messages.

### 3.2.6 Save & Exit Configuration

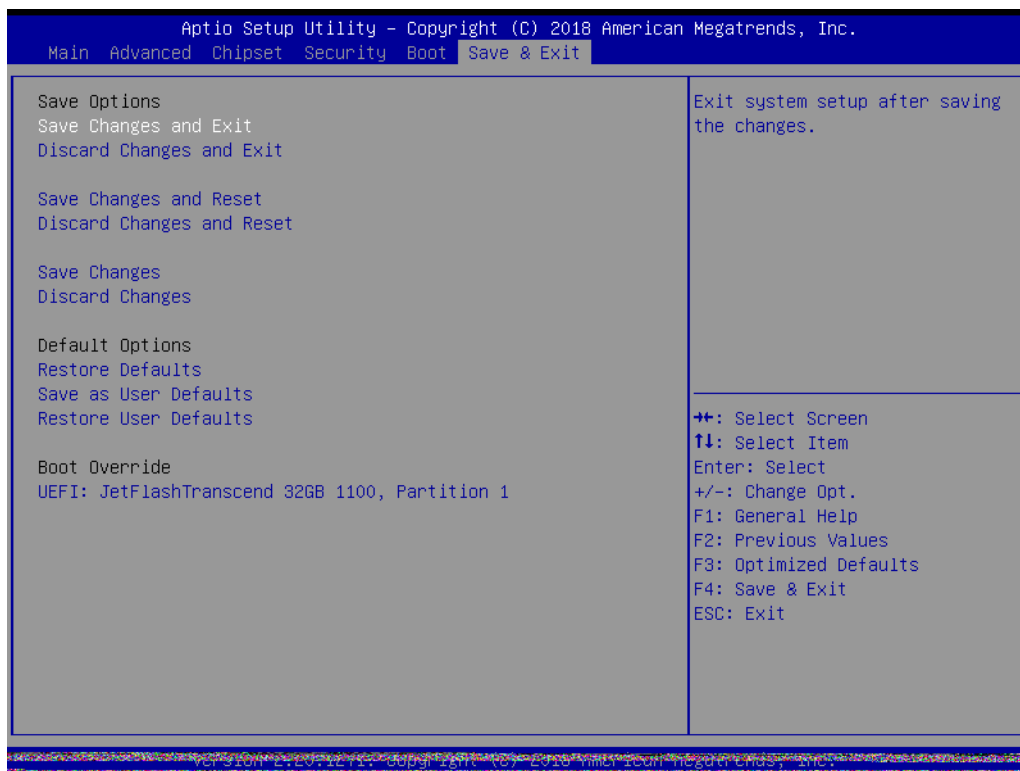

- **Save Changes and Exit**

When users have completed system configuration, select this option to save changes, exit BIOS setup menu and reboot the computer to take effect of all system configuration parameters.

1. Select **Save Changes and Exit** from the Save & Exit menu and press <Enter>. The following message appears: Save Configuration Changes and Exit Now?

2. Select [Ok] or [Cancel]

- **Discard Changes and Exit**

Select this option to quit setup without making any permanent changes to the system configuration.

1. Select **Discard Changes and Exit** from the Save & Exit menu and press <Enter>. The following message appears: Discard Changes and Exit setup Now? [Ok] or [Cancel]

2. Select Ok to discard changes and exit.

- **Save Changes and Reset**

When users have completed system configuration, select this option to save changes, exit BIOS setup menu and reboot the computer to take effect all system configuration parameters.

1. Select **Save Changes and Reset** from the Save & Exit menu and press <Enter>. The following message appears: Save Configuration Changes and Exit Now? [Ok] or [Cancel]

2. Select [Ok] or [Cancel]

- 
- **Discard Changes and Reset**

Select this option to quit Setup without making any permanent changes to the system configuration.

    1. Select **Discard Changes and Reset** from the Save & Exit menu and press <Enter>. The following message appears: Discard Changes and exit setup Now? [Ok] or [Cancel]
    2. Select Ok to discard changes and reset.
  - **Restore Default**

The BIOS automatically configures all setup items to optimal settings when users select this option. Defaults are designed for maximum system performance, but may not work best for all computer applications.

In particular, do not use the Defaults if the user's computer is experiencing system configuration problems. Select Restore Defaults from the Exit menu and press <Enter>.
  - **Save as User Default**

Save the all current settings as a user default.
  - **Restore User Default**

Restore all settings to user default values.
  - **Boot Override**

Shows the boot device types on the system.

# Chapter 4

Software Introduction  
& Service

## 4.1 Introduction

The mission of Advantech Embedded Software Services is to "Enhance quality of life with Advantech platforms and Microsoft® Windows® embedded technology." We enable Windows® Embedded software products on Advantech platforms to more effectively support the embedded computing community. Customers are freed from the hassle of dealing with multiple vendors (hardware suppliers, system integrators, embedded OS distributors) for projects. Our goal is to make Windows® Embedded Software solutions easily and widely available to the embedded computing community.

## 4.2 Value-Added Software Services

Software API: An interface that defines the ways by which an application program may request services from libraries and/or operating systems. Provides not only the underlying drivers required but also a rich set of user-friendly, intelligent and integrated interfaces, which speeds development, enhances security and offers add-on value for Advantech platforms. It plays the role of catalyst between developer and solution, and makes Advantech embedded platforms easier and simpler to adopt and operate with customer applications.

### 4.2.1 Software API

#### 4.2.1.1 Control

##### GPIO



General Purpose Input/Output is a flexible parallel interface that allows a variety of custom connections. It allows users to monitor the level of signal input or set the output status to switch on/off the device. Our API also provide Programmable GPIO, which allows developers to dynamically set the GPIO input or output status.

##### SMBus



SMBus is the System Management Bus defined by Intel Corporation in 1995. It is used in personal computers and servers for low-speed system management communications. The SMBus API allows a developer to interface a embedded system environment and transfer serial messages using the SMBus protocols, allowing multiple simultaneous device control.



#### 4.2.1.2 Display

##### Brightness Control



The Brightness Control API allows a developer to access embedded devices and easily control brightness.

##### Backlight



The Backlight API allows a developer to control the backlight (screen) on/off in embedded devices.

#### 4.2.1.3 Monitor

##### Watchdog



A watchdog timer (WDT) is a device that performs a specific operation after a certain period of time if something goes wrong and the system does not recover on its own. A watchdog timer can be programmed to perform a warm boot (restarting the system) after a certain number of seconds.

##### Hardware Monitor



The Hardware Monitor (HWM) API is a system health supervision API that inspects certain condition indexes, such as fan speed, temperature and voltage.

#### 4.2.1.4 Power Saving

##### CPU Speed



Makes use of Intel SpeedStep technology to save power consumption. The system will automatically adjust the CPU speed depending on the system loading.

##### System Throttling

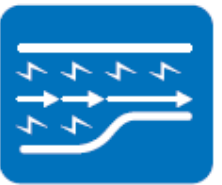

Refers to a series of methods for reducing power consumption in computers by lowering the clock frequency. This API allows the user to adjust the clock from 87.5% to 12.5%.

---

## 4.2.2 Software Utility

### BIOS Flash

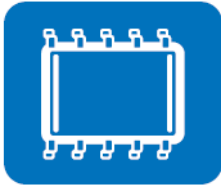

The BIOS Flash utility allows customers to update the flash ROM BIOS version, or use it to back up current BIOS by copying it from the flash chip to a file on customers' disk. The BIOS Flash utility also provides a command line version and an API for fast implementation into customized applications.

### Embedded Security ID



The embedded application is the most important property of a system integrator. It contains valuable intellectual property, design knowledge and innovation, but it is easy to copy! Embedded Security ID utility provides reliable security functions for customers to secure their application data within the embedded BIOS.

### Monitoring



The Monitoring is a utility for customer to monitor the system health, like voltage, CPU and system temperature and fan speed. These items are important to a device, if the critical errors occur and are not solved immediately, permanent damage may be caused.

# Chapter 5

Chipset Software  
Installation Utility

---

## 5.1 Before You Begin

To facilitate the installation of the enhanced display drivers and utility software, read the instructions in this chapter carefully. The drivers for the AIMB-286 are located on Advantech support website: <http://support.advantech.com/Support/>. The driver on the support website will guide and link you to the utilities and drivers under a Windows system. Updates are provided via Service Packs from Microsoft\*.

**Note!** *The driver files on the website are compressed. Do not attempt to install the drivers by copying the files manually. You must download the files and decompress them first. Also, please use the supplied SETUP program to install the drivers.*



Before you begin, it is important to note that most display drivers need to have the relevant software application already installed in the system prior to installing the enhanced display drivers. In addition, many of the installation procedures assume that you are familiar with both the relevant software applications and operating system commands. Review the relevant operating system commands and the pertinent sections of your application software's user manual before performing the installation.

## 5.2 Introduction

The Intel® Chipset Software Installation (CSI) utility installs the Windows INF files that outline to the operating system how the chipset components will be configured. This is needed for the proper functioning of the following features:

- Core PCI PnP services
- Serial ATA interface support
- USB support
- Identification of Intel® chipset components in the Device Manager

**Note!** *This utility is used for the following versions of Windows, and it has to be installed **before** installing all the other drivers:*



- Windows 10 (64-bit)

# Chapter 6

## VGA Setup

## 6.1 Introduction

The 8th Gen Intel Core i processors are embedded with an integrated graphics controller. You need to install the VGA driver to enable the function.

Optimized integrated graphic solution: Intel Graphics Flexible supports versatile display options and a 32-bit 3D graphics engine. Dual independent displays include enhanced display modes for widescreen flat panels for, extended, twin, clone and dual display modes, and optimized 3D support delivers an intensive and realistic visual experience.

## 6.2 Windows 10 VGA Driver Installation

**Note!** *Before installing this driver, make sure the CSI utility has been installed in your system. See Chapter 5 for information on installing the CSI utility.*



Download the driver from website on your computer. Navigate to the "AIMB-286\_Graphic\_Win10(64bit)" folder and click "setup.exe" to complete the installation of the drivers for Windows 10.

### Win 10(64bit) Driver for AIMB-286

Solution : Win 10(64bit) Driver for AIMB-286

Download File	Released Date	Download Site	
AIMB-286_Audio_Win10(64bit).zip	2019-01-23	<a href="#">Primary</a>	<a href="#">Secondary</a>
AIMB-286_Chipset_Win10(64bit).zip	2019-01-23	<a href="#">Primary</a>	<a href="#">Secondary</a>
AIMB-286_Graphic_Win10(64bit).zip	2019-01-23	<a href="#">Primary</a>	<a href="#">Secondary</a>
AIMB-286_Intel ME_AMT_Win10(64bit).zip	2019-01-23	<a href="#">Primary</a>	<a href="#">Secondary</a>
AIMB-286_Intel_LAN_Win10(64bit).zip	2019-01-23	<a href="#">Primary</a>	<a href="#">Secondary</a>
AIMB-286_Realtek LAN_Win10(64bit).zip	2019-01-23	<a href="#">Primary</a>	<a href="#">Secondary</a>
AIMB-286_Serial IO_Win10(64bit).zip	2019-01-23	<a href="#">Primary</a>	<a href="#">Secondary</a>

# Chapter 7

## LAN Configuration

## 7.1 Introduction

The AIMB-286 has three Gigabit Ethernet LANs via dedicated PCI Express x1 lanes (Realtek 8111G (LAN1/2) and Intel i211AT (LAN3)) that offer bandwidth of up to 500 MB/sec, eliminating the bottleneck of network data flow and incorporating Gigabit Ethernet at 1000 Mbps.

## 7.2 Features

- Integrated 10/100/1000 Mbps transceiver
- 10/100/1000 Mbps triple-speed MAC
- High-speed RISC core with 24-KB cache
- On-chip voltage regulation
- Wake-on-LAN (WOL) support
- PCI Express X1 host interface

## 7.3 Installation

**Note!** Before installing this driver, make sure the CSI utility has been installed in your system. See Chapter 5 for information on installing the CSI utility.



The AIMB-286's Realtek 8111G (LAN1/2) and Intel i211AT (LAN3) Gigabit integrated controllers support all major network operating systems. However, the installation procedure varies from system to system. Please find and use the section that provides the driver setup procedure for the OS you are using.

## 7.4 Windows® 10 Driver Setup (Realtek 8111G & Intel i211AT)

Download the driver from support website on your computer and decompressed the file. Select the "Autorun" then navigate to the directory for your OS.

Win 10(64bit) Driver for AIMB-286

Solution : Win 10(64bit) Driver for AIMB-286

Download File	Released Date	Download Site	
AIMB-286_Audio_Win10(64bit).zip	2019-01-23	Primary	Secondary
AIMB-286_Chipset_Win10(64bit).zip	2019-01-23	Primary	Secondary
AIMB-286_Graphic_Win10(64bit).zip	2019-01-23	Primary	Secondary
AIMB-286_Intel ME_AMT_Win10(64bit).zip	2019-01-23	Primary	Secondary
AIMB-286_Intel_LAN_Win10(64bit).zip	2019-01-23	Primary	Secondary
AIMB-286_Realtek LAN_Win10(64bit).zip	2019-01-23	Primary	Secondary
AIMB-286_Serial IO_Win10(64bit).zip	2019-01-23	Primary	Secondary



# Appendix **A**

I/O Pin Assignments

## A.1 DC input Phoenix Connector (DCIN1)

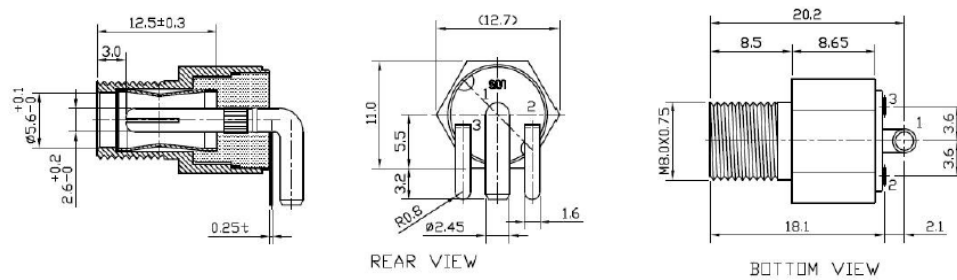

Pin	Signal Pin Definition
1	Power input (Only +12V)
2	GND
3	GND

## A.2 Definition Multimedia Interface (DP1+HDMI1)

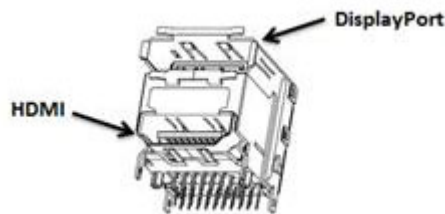

Pin	Signal Pin Definition	Pin	Signal Pin Definition
1	HDMI1_Z_D2+	A1	DP1_0+
2	GND	A2	GND
3	HDMI1_Z_D2-	A3	DP1_0-
4	HDMI1_Z_D1+	A4	DP1_1+
5	GND	A5	GND
6	HDMI1_Z_D1-	A6	DP1_1-
7	HDMI1_Z_D0+	A7	DP1_2+
8	GND	A8	GND
9	HDMI1_Z_D0-	A9	DP1_2-
10	HDMI1_Z_CLK+	A10	DP1_3+
11	GND	A11	GND
12	HDMI1_Z_CLK-	A12	DP1_3-
13	x	A13	DP1_AUX_EN#
14	x	A14	GND
15	HDMI1_SCL	A15	DP1_AUX+
16	HDMI1_SDA	A16	GND
17	GND	A17	DP1_AUX-
18	+V5_HDMI	A18	DP1_HPD
19	HDMI1_HPD	A19	GND
		A20	+V3.3_DP1

### A.3 ATX Power supply (5VSB) connector (ATX\_5VSB1)

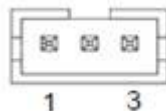

Pin	Signal Pin Definition
1	+V5SB
2	GND
3	PS_ON#

### A.4 USB 3.0 Stack Connector (USB12)



Pin	Signal Pin Definition	Pin	Signal Pin Definition
1	+5V	11	+5V
2	USB_D1-	12	USB_D2-
3	USB_D1+	13	USB_D2+
4	GND	14	GND
5	USB31X1_z_RX-	15	USB31X2_z_RX-
6	USB31X1_z_RX+	16	USB31X2_z_RX+
7	GND	17	GND
8	USB31X1_z_TX-	18	USB31X2_z_TX-

## A.5 USB 3.0 Stack Connector (USB34)



Pin	Signal Pin Definition	Pin	Signal Pin Definition
1	+5V	11	+5V
2	USB_D3-	12	USB_D4-
3	USB_D3+	13	USB_D4+
4	GND	14	GND
5	USB31X3_z_RX-	15	USB31X4_z_RX-
6	USB31X3_z_RX+	16	USB31X4_z_RX+
7	GND	17	GND
8	USB31X3_z_TX-	18	USB31X4_z_TX-

## A.6 RJ45 2 Port (LAN12)

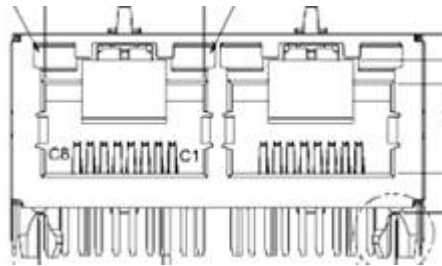

Pin	Signal Pin Definition	Pin	Signal Pin Definition
B1	LAN1_MDI0+	A1	LAN2_MDI0+
B2	LAN1_MDI0-	A2	LAN2_MDI0-
B3	LAN1_MDI1+	A3	LAN2_MDI1+
B4	LAN1_MDI1-	A4	LAN2_MDI1-
B5	LAN1_CONN	A5	LAN2_CONN
B6	LAN1_CT	A6	LAN2_CT
B7	LAN1_MDI2+	A7	LAN2_MDI2+
B8	LAN1_MDI2-	A8	LAN2_MDI2-
B9	LAN1_MDI3+	A9	LAN2_MDI3+
B10	LAN1_MDI3-	A10	LAN2_MDI3-
B11	LAN1_LED0_ACT#_R	A11	LAN2_LED0_ACT#_R
B12	+V3.3_DUAL	A12	+V3.3_DUAL
B13	LAN1_LED1_1G#_R	A13	LAN2_LED1_1G#_R
B14	LAN1_LED2_100M#_R	A14	LAN2_LED2_100M#_R

## A.7 Platform Controller Hub (PCH1)

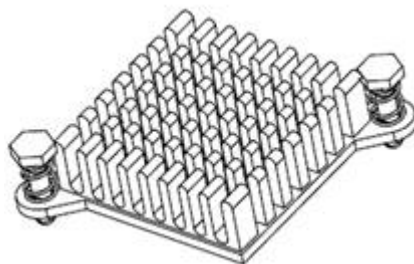
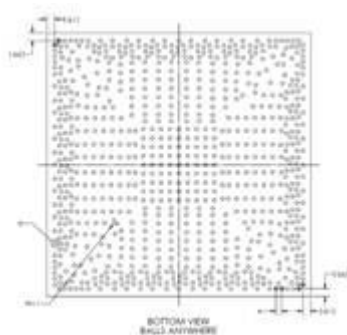

## A.8 RJ45 1 Port (LAN1)

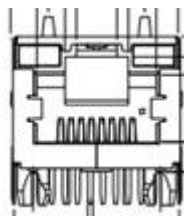

Pin	Signal Pin Definition
1	LAN1_MDI0+
2	LAN1_MDI0-
3	LAN1_MDI1+
4	LAN1_MDI1-
5	LAN1_CONN
6	LAN1_CT
7	LAN1_MDI2+
8	LAN1_MDI2-
9	LAN1_MDI3+
10	LAN1_MDI3-
11	LAN1_LED0_ACT#_R
12	+V3.3_DUAL
13	LAN1_LED1_1G#_R
14	LAN1_LED2_100M#_R

## A.9 SATA Signal Connector (SATA2)

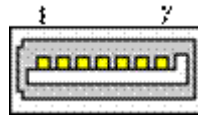

Pin	Signal Pin Definition
1	GND
2	TX+
3	TX-
4	GND
5	RX-
6	RX+
7	GND

## A.10 RJ45 1 Port (LAN3)

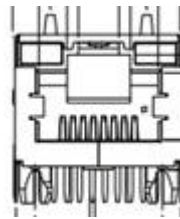

Pin	Signal Pin Definition
1	LAN3_MDIO+
2	LAN3_MDIO-
3	LAN3_MDII+
4	LAN3_MDII-
5	LAN3_CONN
6	LAN3_CT
7	LAN3_MDI2+
8	LAN3_MDI2-
9	LAN3_MDI3+
10	LAN3_MDI3-
11	LAN3_LED0_ACT#_R
12	+V3.3_LAN3_R
13	LAN3_LED1_1G#_R
14	LAN3_LED2_100M#_R

## A.11 Battery Wafer Box (BAT1)



Pin	Signal Pin Definition
1	VBAT
2	GND

## A.12 HD Analog Audio Interface (AUDIO1)

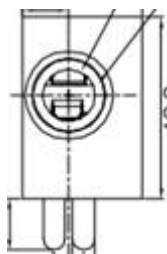

Pin	Signal Pin Definition
1	LINE-OUT

## A.13 HD Analog Audio Interface (AUDIO2)

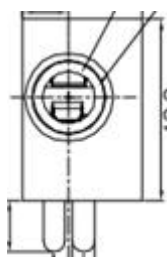

Pin	Signal Pin Definition
1	MIC

## A.14 Front HD Analog Audio Interface (FPAUD1)

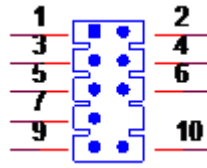

Pin	Signal Pin Definition	Pin	Signal Pin Definition
1	MIC IN L	2	GND
3	MIC IN R	4	FPAUD_DETECT#
5	LINE OUT R	6	SENSE R1
7	SENSE	8	KEY
9	LINE OUT L	10	SENSE R2

## A.15 Audio Amplifier Output Connector (AMP1)



Pin	Signal Pin Definition
1	R+
2	R-
3	L-
4	L+

## A.16 HD Digital Audio Interface (SPDIF1)

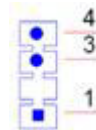

Pin	Signal Pin Definition
1	+5V
2	SPDIF OUT
3	GND



## A.17 SATA Signal Connector (SATA1)

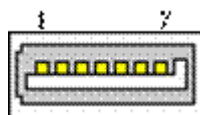

Pin	Signal Pin Definition
1	GND
2	TX+
3	TX-
4	GND
5	RX-
6	RX+
7	GND

## A.18 PCI-E x4 Slot (PCIEX4\_1)

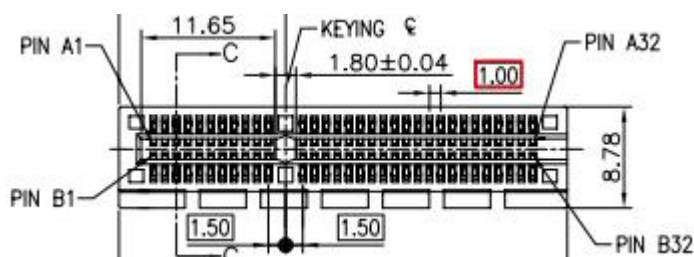

Pin	Signal Pin Definition	Pin	Signal Pin Definition
B1	+12V	A1	PRSNT1#
B2	+12V	A2	+12V
B3	+12V	A3	+12V
B4	GND	A4	GND
B5	SMB_CLK	A5	Reserved
B6	SMB_DATA	A6	Reserved
B7	GND	A7	Reserved
B8	+3.3V	A8	Reserved
B9	Reserved	A9	+3.3V
B10	+3.3VAUX	A10	+3.3V
B11	WAKE#	A11	PWRGD
B12	Reserved	A12	GND
B13	GND	A13	REFCLK+
B14	TX0+	A14	REFCLK-
B15	TX0-	A15	GND
B16	GND	A16	RX0+
B17	Reserved	A17	RX0-
B18	DETECT#	A18	GND
B19	TX1+	A19	CONFIG1
B20	TX1-	A20	GND

B21	GND	A21	RX1+
B22	GND	A22	RX1-
B23	TX2+	A23	GND
B24	TX2-	A24	GND
B25	GND	A25	RX2+
B26	GND	A26	RX2-
B27	TX3+	A27	GND
B28	TX3-	A28	GND
B29	GND	A29	RX3+
B30	Reserved	A30	RX3-
B31	Reserved	A31	GND
B32	GND	A32	CONFIG2

## A.19 NGFF M.2 E-Key connector for 2230 module (M2E1)

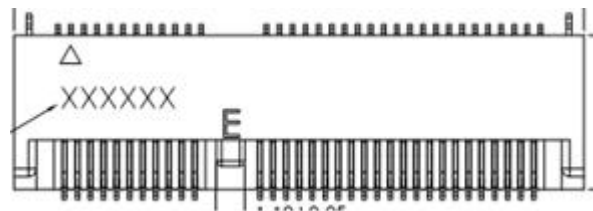

Pin	Signal Pin Definition <sup>6</sup>	Pin	Signal Pin Definition
1	GND	2	+3.3V
3	USB_D+	4	+3.3V
5	USB_D-	6	LED1# (I)(OD)
7	GND	8	PCM_CLK/I2S SCK (O/I)(0/1.8V)
9	CNV_WR_z_D1-	10	PCM_SYNC/I2S WS (I/O)(0/1.8V)
11	CNV_WR_z_D1+	12	PCM_IN/I2S SD_IN (I)(0/1.8V)
13	GND	14	PCM_OUT/I2S SD_OUT (O)(0/1.8V)
15	CNV_WR_z_D0-	16	LED2# (I)(OD)
17	CNV_WR_z_D0+	18	GND
19	GND	20	UART WAKE# (I)(0/3.3V)
21	CNV_WR_z_CLK-	22	UART RXD (I)(0/1.8V)
23	CNV_WR_z_CLK+	24	Connector KEY
25	Connector KEY	26	Connector KEY
27	Connector KEY	28	Connector KEY
29	Connector KEY	30	Connector KEY
31	Connector KEY	32	CNV_RGI_DT
33	GND	34	CNV_RGI_RSP
35	PETp0	36	CNV_BRI_DT
37	PETn0	38	PCH_CLINK_RST#
39	GND	40	PCH_CLINK_DATA
41	PERp0	42	PCH_CLINK_CLK
43	PERn0	44	CNV_GNSS_BLANKING

45	GND	46	CNV_MFUART2_TXD
47	REFCLKp0	48	CNV_MFUART2_RXD
49	REFCLKn0	50	SUSCLK(32kHz) (O)(0/3.3V)
51	GND	52	PERST0# (O)(0/3.3V)
53	CLKREQ0#	54	W_DISABLE2# (O)(0/3.3V)
55	PEWAKE0#	56	W_DISABLE1# (O)(0/3.3V)
57	GND	58	RESERVED
59	RESERVED/PETp1	60	RESERVED
61	RESERVED/PETn1	62	RESERVED
63	GND	64	M.2_38P4M_REFCLK
65	RESERVED/PERp1	66	RESERVED
67	RESERVED/PERn1	68	RESERVED
69	GND	70	PCIE_WAKE#
71	RESERVED/REFCLKp1	72	+3.3V
73	RESERVED/REFCLKn1	74	+3.3V
75	GND		

## A.20 SATA Signal Connector (SATA3)

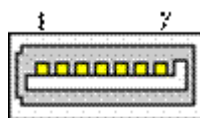

Pin	Signal Pin Definition
1	GND
2	TX+
3	TX-
4	GND
5	RX-
6	RX+
7	GND

## A.21 NGFF M.2 B-Key connector for 2242/3042 module (M2B1)

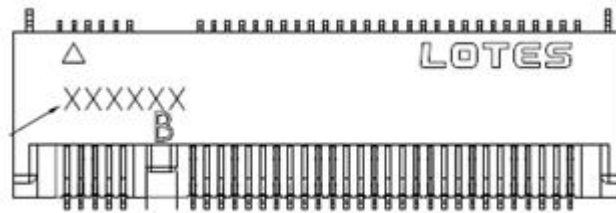

Pin	Signal Pin Definition <sup>6</sup>	Pin	Signal Pin Definition
1	CONFIG_3	2	+3.3V
3	GND	4	+3.3V
5	GND	6	FULL_CARD_POWER_OFF#
7	USB_D+	8	W_DISABLE1#
9	USB_D-	10	LED
11	GND	12	Connector KEY
13	Connector KEY	14	Connector KEY
15	Connector KEY	16	Connector KEY
17	Connector KEY	18	Connector KEY
19	Connector KEY	20	N/C
21	CONFIG_0	22	N/C
23	PCIE_WAKE#	24	N/C
25	DPR	26	M.2_GNSS_DISABLE#
27	GND	28	N/C
29	PERn1/USB3.0-Rx-/SSIC-RxN	30	UIM-RESET (I)
31	PERp1/USB3.0-Rx+/SSIC-RxP	32	UIM-CLK (I)
33	GND	34	UIM-DATA (I/O)
35	PETn1/USB3.0-Tx-/SSIC-TxN	36	UIM-PWR (I)
37	PETp1/USB3.0-Tx+/SSIC-TxP	38	SATA_DEVSLP (O)
39	GND	40	M.2_ISH_SCL
41	PERn0/SATA-B+	42	M.2_ISH_SDA
43	PERp0/SATA-B-	44	N/C
45	GND	46	N/C
47	PETn0/SATA-A-	48	N/C
49	PETp0/SATA-A+	50	PERST#
51	GND	52	CLKREQ#
53	REFCLKn	54	PEWAKE#
55	REFCLKp	56	N/C
57	GND	58	N/C
59	N/C	60	N/C
61	N/C	62	N/C
63	N/C	64	N/C
65	N/C	66	N/C
67	RESET#	68	SUSCLK(32kHz)
69	CONFIG_1	70	+3.3V

71	GND	72	+3.3V
73	GND	74	+3.3V
75	CONFIG_2		

## A.22 USB 2.0 Pin Header (USB56)

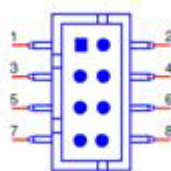

Pin	Signal Pin Definition	Pin	Signal Pin Definition
1	+5V	2	+5V
3	USB_D5-	4	USB_D6-
5	USB_D5+	6	USB_D6+
7	GND	8	GND

## A.23 USB 2.0 Pin Header (USB78)

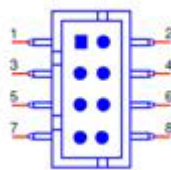

Pin	Signal Pin Definition	Pin	Signal Pin Definition
1	+5V	2	+5V
3	USB_D7-	4	USB_D8-
5	USB_D7+	6	USB_D8+
7	GND	8	GND

## A.24 General Purpose I/O Pin Header (GPIO1)

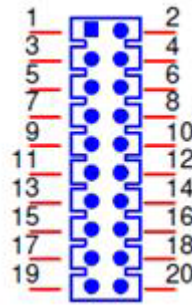

Pin	Signal Pin Definition	Pin	Signal Pin Definition
1	GPIO0	2	GPIO8
3	GPIO1	4	GPIO9
5	GPIO2	6	GPIO10
7	GPIO3	8	GPIO11
9	GPIO4	10	GPIO12
11	GPIO5	12	GPIO13
13	GPIO6	14	GPIO14
15	GPIO7	16	GPIO15
17	+5VSB	18	GND
19	+5VSB	20	GND

## A.25 DDR4 SO-DIMM Socket (DIMMA1)

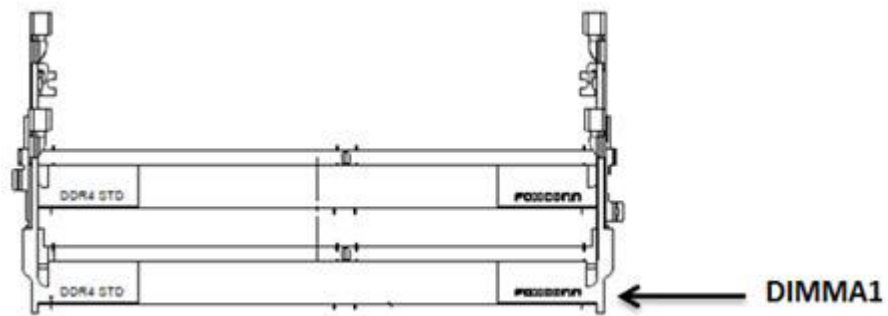

Please see JEDEC STANDARD Pin Definition

## A.26 DDR4 SO-DIMM Socket (DIMMB1)

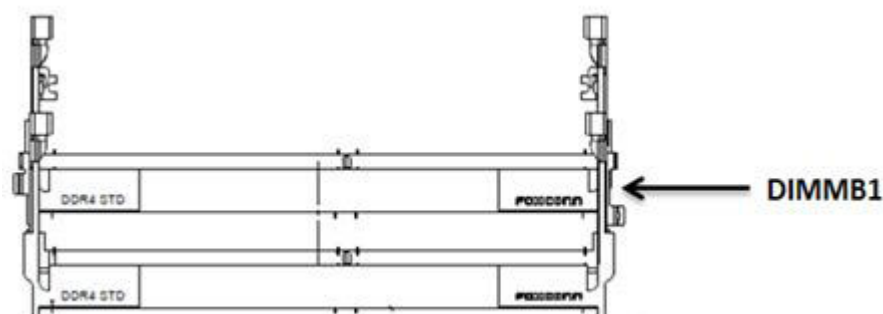

Please see JEDEC STANDARD Pin Definition

## A.27 COM 4 Port (COM3456)

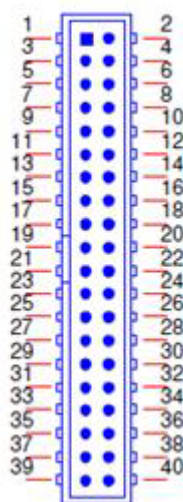

Pin	Signal Pin Definition	Pin	Signal Pin Definition
1	DCD# [3]	2	DSR# [3]
3	RXD [3]	4	RST# [3]
5	TXD [3]	6	CTS# [3]
7	DTR# [3]	8	RI# [3]
9	GND	10	GND
11	DCD# [4]	12	DSR# [4]
13	RXD [4]	14	RST# [4]
15	TXD [4]	16	CTS# [4]
17	DTR# [4]	18	RI# [4]
19	GND	20	GND
21	DCD# [5]	22	DSR# [5]
23	RXD [5]	24	RST# [5]
25	TXD [5]	26	CTS# [5]
27	DTR# [5]	28	RI# [5]
29	GND	30	GND
31	DCD# [6]	32	DSR# [6]

33	RXD [6]	34	RST# [6]
35	TXD [6]	36	CTS# [6]
37	DTR# [6]	38	RI# [6]
39	GND	40	GND

## A.28 PS/2 Keyboard and Mouse Connector (KBMS1)

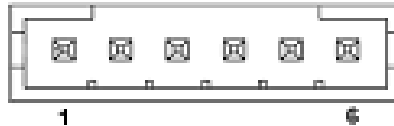

Pin	Signal Pin Definition
1	KB CLK
2	KB DATA
3	MS CLK
4	GND
5	+5V
6	MS DATA

## A.29 Low Pin Count Header (LPC1)

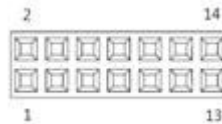

Pin	Signal Pin Definition	Pin	Signal Pin Definition
1	CLK (24MHz)	2	AD1
3	RESET#	4	AD0
5	FRAME#	6	+3.3V
7	AD3	8	GND
9	AD2	10	SMB_CLK
11	SERIRQ	12	SMB_DATA
13	+5VSB	14	+5V



## A.30 COM 2 Port (COM12)

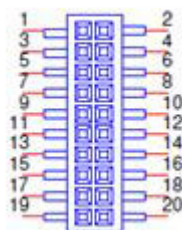

Pin	Signal Pin Definition	Pin	Signal Pin Definition
1	DCD# [1]	2	DSR# [1]
3	RXD [1]	4	RST# [1]
5	TXD [1]	6	CTS# [1]
7	DTR# [1]	8	RI# [1]
9	GND	10	GND
11	DCD# [2]	12	DSR# [2]
13	RXD [2]	14	RST# [2]
15	TXD [2]	16	CTS# [2]
17	DTR# [2]	18	RI# [2]
19	GND	20	GND

## A.31 Power LED and Keyboard Lock Pin Header (JFP2)

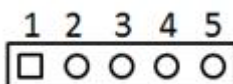

Pin	Signal Pin Definition
1	LED Power
2	N/C
3	GND
4	Keyboard LOCK#
5	GND

## A.32 Case-Open Detect Connector (JCASE1)



Pin	Signal Pin Definition
1	Case Open
2	GND

## A.33 SPI Programming Pin Header (SPI\_CN1)

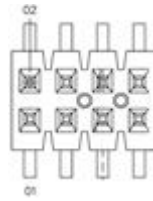

Pin	Signal Pin Definition	Pin	Signal Pin Definition
1	CS#	2	+3.3V
3	MISO	4	X
5	X	6	SCK
7	GND	8	MOSI

## A.34 SPI BIOS Flash Socket (SPI1)

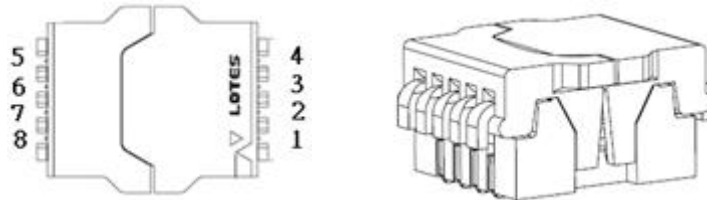

Pin	Signal Pin Definition	Pin	Signal Pin Definition
1	CS#	5	MOSI
2	MISO	6	SCK
3	WP# / IO2	7	HOLD# / IO3
4	GND	8	+3.3V

## A.35 SYSTEM FAN Power Connector (SYSFAN1)

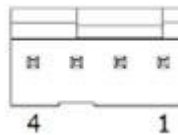

Pin	Signal Pin Definition
1	GND
2	SYSTEM FAN VCC
3	SYSTEM FAN SPEED
4	SYSTEM FAN PWM

## A.36 SYSTEM FAN Power Connector (SYSFAN2)



Pin	Signal Pin Definition
1	GND
2	SYSTEM FAN VCC
3	SYSTEM FAN SPEED
4	SYSTEM FAN PWM

## A.37 TI's SMBUS Programming for +Vcore/+VCCGT Controller (JSMB1)

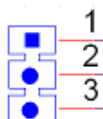

Pin	Signal Pin Definition
1	TPS53655_SMB_CLK
2	TPS53655_SMB_DIO
4	GND

## A.38 LGA1151 CPU Socket H4 (CPU1)

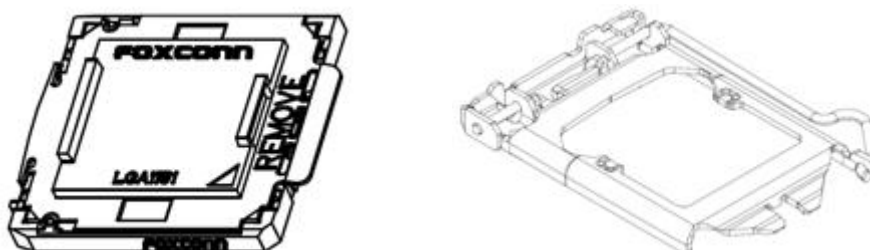

## A.39 CPU FAN Power Connector (CPUFAN1)

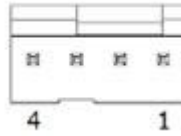

Pin	Signal Pin Definition
1	GND
2	CPU FAN VCC
3	CPU FAN SPEED
4	CPU FAN PWM

## A.40 LVDS Backlight Inverter Power Connector (INV1)



Pin	Signal Pin Definition
1	+12V
2	GND
3	BKL_EN
4	BKL_CTRL
5	+5V

## A.41 SATA Power Connector (SATA\_PWR2)

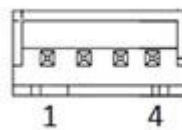

Pin	Signal Pin Definition
1	+V5
2	GND
3	GND
4	+V12

## A.42 SATA Power Connector (SATA\_PWR1)

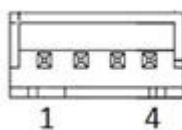

Pin	Signal Pin Definition
1	+V5
2	GND
3	GND
4	+V12

## A.43 eDP/LVDS Panel Connector (LVDS\_EDP1)

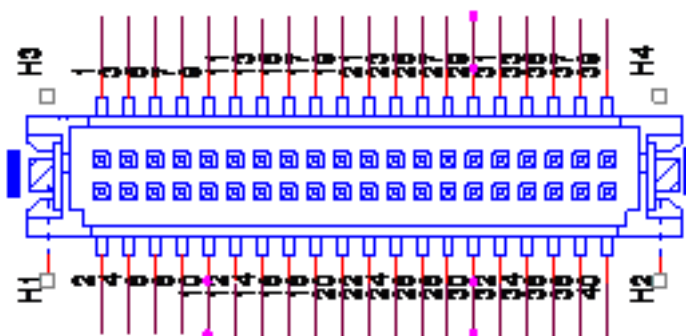

Pin	Signal Pin Definition	Pin	Signal Pin Definition
1	VDD	2	VDD
3	LVDS_DET#	4	GND
5	VDD	6	VDD
7	A0N(EDP_CPU_TXN2)	8	A4N
9	A0P(EDP_CPU_TXP2)	10	A4P
11	GND	12	GND
13	A1N	14	A5N
15	A1P	16	A5P
17	GND	18	GND
19	A2N	20	A6N
21	A2P	22	A6P
23	GND	24	GND
25	CLK1N(EDP_CPU_TXN3)	26	CLK2N
27	CLK1P(EDP_CPU_TXP3)	28	CLK2P
29	GND	30	GND
31	SCD	32	SDD
33	GND	34	GND(EDP_CH7511_HPD)
35	A3N	36	A7N
37	A3P	38	A7P
39	ENBKL	40	VCON

## A.44 ATX 12V Power Supply Connector (ATX12V1)



Pin	Signal Pin Definition
1	GND
2	GND
3	+12V
4	+12V

## A.45 SIM Card Connector (SIM1)



Pin	Signal Pin Definition
C1	UIM_PWR
C2	UIM_RESET
C3	UIM_CLK
C5	GND
C6	UIM_VPP
C7	UIM_DATA

## A.46 Buzzer (SP1)



## A.47 CPU Back Plate (CPU0\_BACKPLATE1)

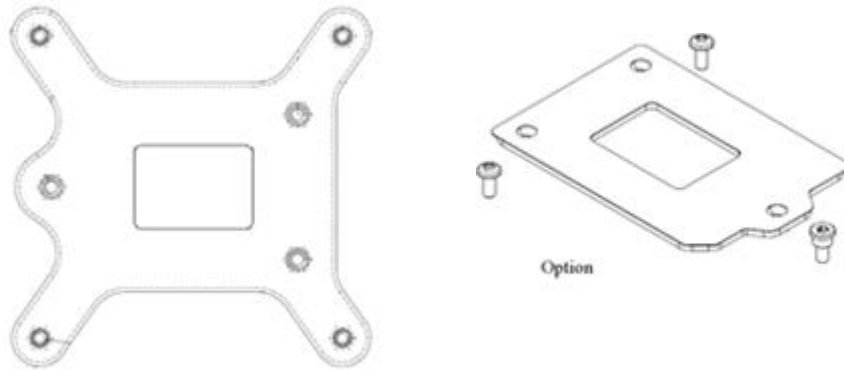

**ADVANTECH**

*Enabling an Intelligent Planet*

**[www.advantech.com](http://www.advantech.com)**

Please verify specifications before quoting. This guide is intended for reference purposes only.

All product specifications are subject to change without notice.

No part of this publication may be reproduced in any form or by any means, electronic, photocopying, recording or otherwise, without prior written permission of the publisher.

All brand and product names are trademarks or registered trademarks of their respective companies.

© Advantech Co., Ltd. 2019